



Mobile Multimedia Station

IVA-D105



MP3 AAC



HD Radio™
READY



dts™
Digital Surround

- **OWNER'S MANUAL**
Please read before using this equipment.
- **MODE D'EMPLOI**
Veuillez lire avant d'utiliser cet appareil.
- **MANUAL DE OPERACIÓN**
Léalo antes de utilizar este equipo.

ALPINE ELECTRONICS MARKETING, INC.
1-1-8 Nishi Gotanda,
Shinagawa-ku,
Tokyo 141-0031, Japan
Phone 03-5496-8231

ALPINE ELECTRONICS OF AMERICA, INC.
19145 Gramercy Place, Torrance,
California 90501, U.S.A.
Phone 1-800-ALPINE-1 (1-800-257-4631)

ALPINE ELECTRONICS OF CANADA, INC.
777 Superstest Road, Toronto,
Ontario M3J 2M9, Canada
Phone 1-800-ALPINE-1 (1-800-257-4631)

ALPINE ELECTRONICS OF AUSTRALIA PTY. LTD.
161-165 Princes Highway, Hallam
Victoria 3803, Australia
Phone 03-8787-1200

ALPINE ELECTRONICS GmbH
Frankfurter Ring 117, 80807 München, Germany
Phone 089-32 42 640

ALPINE ELECTRONICS OF U.K. LTD.
Alpine House
Fletchamstead Highway, Coventry CV4 9TW, U.K.
Phone 0870-33 33 763

ALPINE ELECTRONICS FRANCE S.A.R.L.
(RCS PONTOISE B 338 101 280)
98, Rue de la Belle Etoile, Z.I. Paris Nord II,
B.P. 50016, 95945 Roissy Charles de Gaulle
Cedex, France
Phone 01-48638989

ALPINE ITALIA S.p.A.
Viale C. Colombo 8, 20090 Trezzano
Sul Naviglio (MI), Italy
Phone 02-484781

ALPINE ELECTRONICS DE ESPAÑA, S.A.
Portal de Gamarra 36, Pabellón, 32
01013 Vitoria (Alava)-APDO 133, Spain
Phone 945-283588

ALPINE ELECTRONICS (BENELUX) GmbH
Leuvensesteenweg 510-B6,
1930 Zaventem, Belgium
Phone 02-725-13 15

Contents

Operating Instructions

WARNING

WARNING	5
CAUTION	5
PRECAUTIONS	6
Discs Playable on This Unit	7

Getting Started

Accessory List	10
Location of Controls	10
Detaching and Attaching the Front Panel	11
Initial System Start-Up	11
Turning Power On or Off	11
Opening/Closing the Monitor	11
Moving the Monitor to be Flat	12
Adjusting the Volume	12
Lowering Volume Quickly	12
How to view the Display	12
PULSETOUCH™ operation	12
Recalling the Source	12
Displaying the Numeric Keypad Input Screen	13

Radio

Listening to the Radio	14
Manual Storing of Station Presets	14
Automatic Memory of Station Presets	14
Tuning to Preset Stations	14
Changing the Display (HD Radio mode only)	15
Displaying a List of the Program (HD Radio mode only)	15
Receiving a Multicast (HD Radio mode only)	15

CD/MP3/WMA/AAC

Playback	16
Repeat Play	16
M.I.X. (Random Play)	16
Selecting Folders (concerning MP3/WMA/AAC)	16
About MP3/WMA/AAC	17

DVD/Video CD

Playing a Disc	19
To display the DVD mode screen	19
If a menu screen appears	20
Displaying the Top Menu Screen	21
Displaying the Menu Screen	21
Displaying the Menu Operation Mode Screen	21
Searching by Program	21
Searching by Playlist	21
Stopping Playback (PRE STOP)	21
Stopping Playback	22
Fast-forwarding/Fast-reversing	22
Finding the Beginnings of Chapters/ Tracks/Files	22
Playing Still Frames (Pausing)	22
Forward/reverse frame-by-frame Playback	22
Slow Motion Playback	22
Selecting Program (SKIP)	23
Selecting Playlist (SKIP)	23
Selecting Folders	23
Repeat Playback	23
Searching by Title/Group/Program/Playlist/ Folder Number	24
Searching Directly by Chapter, Track or File Number	24
Switching the Angle	25
Scroll to Move the Page Forward or Back	25
Switching the Audio Tracks	25
Switching the Subtitles (Subtitle Language)	25
Switching from the disc menu	25
Displaying the Disc Status for DVD/Video CD	26
About DivX®	26

Other Useful Features

Adjusting the Audio (Adjust the Bass/Treble/ Balance/Fader/Loudness/Subwoofer/ NAV. LEVEL/Defeat)	26
Search Function	27
Rear Selection Function	28
Switching Display Modes	28
Switching the Visual Source Only (Simultaneous Function)	28
Cancelling the Simultaneous Function	28
Blackout Mode On and Off	29
Setting rear Camera Interruption	29

Setup

DVD Setup

DVD Setup Operation	29
Changing the language setting	30
Setting of the Menu Language	30
Setting of the Audio Language	30
Setting of the Subtitle Language	30
Changing the Country Code Setting	30
Setting the Rating Level (Parental Lock)	31
Changing the Digital Output Setting	31
Setting the Downmix Mode	33
Setting the TV Screen	33
Setting of the Bonus Code	33
Setting the DVD-Audio Playback Mode	33
Setting the compressed File Playback Data	34
Playing MP3/WMA/AAC Data	34
Displaying DivX [®] Disc Information	34
Setting the Video CD Play Mode	34

RADIO Setup

Digital SEEK Setting (HD Radio mode only)	34
--	----

GENERAL Setup

General Setup Operation	35
Displaying the Time	35
Setting the Time	35
Setting Daylight Saving Time	35
Demonstration Function	35
Sound (Beep) Guide Function	35
Setting the Scroll	36
Changing the Russian Font	36
Adjusting the Dimmer of Button Lighting at Night	36

SYSTEM Setup

System Setup Operation	36
Setting the External Device Interrupt Mode	37
Setting the Interrupt Icon Display	37
Switching the function of the remote sensor	37
Setting the Navigation Mode	37
Setting the Navigation Interruption	37
Setting the AUX Mode	37
Adjusting the External Input Audio Level ..	38
Setting the USB Adapter to ON/OFF	38
Setting the Rear Camera Input	38
Setting the Picture/Sound Output	38
Setting the Bluetooth Connection (Bluetooth IN)	38
Setting the VISUAL Button	38
Subwoofer On and Off	38
Setting the Digital Output	38

DISPLAY Setup

Display Setup Operation	39
Adjusting the Monitor Angle	39
Setting Automatic Opening/Closing of the Monitor	39
Setting the Brightness of the Backlighting ..	39
Adjusting the Minimum Level of Backlight	39
Switching Background Textures	40
Setting Automatic Background Textures	40
Switching the Font Background Color	40
Turning the Touch Panel Vibration ON or OFF	40
Adjusting the Touch Panel	40

VISUAL EQ™

Visual EQ Setting Operation	41
Selecting the VISUAL EQ Mode (Maker's setting)	41
Adjusting Brightness	41
Adjusting Color of Picture	41
Adjusting Tint of Picture	41
Adjusting Image Contrast	41
Adjusting Picture Quality	42
Storing VISUAL EQ	42

Data Download

Downloading the BACKGROUND data	42
---------------------------------------	----

Adjusting Sound

BassEngine Operation

BassEngine Operation	43
----------------------------	----

External Audio Processor Operation

External Audio Processor (Optional)	43
Adjustment Procedure for Dolby Surround	44
Setting the Speakers	44
Set MX Mode of the External Audio Processor	45
X-OVER Adjustment	45
Performing Time Correction Manually (TCR)	46
Phase Switching	47
Graphic Equalizer Adjustments	47
Parametric Equalizer Adjustments	47
Setting Bass Sound Control	48
Setting Bass Compressor	48
Setting Bass Focus	48
Speaker Setup	48
Setting of Dolby Digital	48
Adjusting the acoustic image (BI-PHANTOM)	49
Mixing bass sound to the rear channel (REAR MIX)	49
Achieving powerful high volume sound (LISTENING MODE)	49
Adjusting the speaker levels (OUTPUT LEVEL)	49
Setting the Output Channel (OUTPUT MODE)	49
Adjusting the DVD Level	50
Storing Settings in the Memory	50
Recalling the Preset Memory	50
Using the Pro Logic II Mode	50
Linear PCM Setting	50

Navigation System (Optional)

Switching the Navigation Screen (Optional) ..	51
Portable Navigation System Operation (Optional)	51

Auxiliary Device (Optional)

Operating Auxiliary Devices (Optional)	51
--	----

Changer (Optional)

Controlling CD Changer (Optional)	52
Multi-Changer Selection (Optional)	53

SAT Radio Receiver (Optional)

Receiving Channels with the SAT Receiver (Optional)	53
Tuning in to Categorized Programs	54
Changing the Display	54
Checking the SAT Radio ID Number	54
Storing Channel Presets	54
Receiving Stored Channels	54
Search Function (XM mode)	55
Search Function (SIRIUS mode)	55
Selecting the Channel directly	55
Receiving Weather or Traffic information from SAT Radio	56
Storing the desired Song/Artist (SIRIUS mode only)	56
Storing favorite Sports Teams (SIRIUS mode only)	56
Receiving the stored information (SIRIUS mode only)	56
Offset Playback Function (SIRIUS mode only)	57

SIRIUS Setup

SIRIUS Setup Operation	57
Setting the announcement individually for a Song / Artist / Sports Team	57
Setting ON/OFF of all Songs/ Artists Interruption	57
Setting the sports team announcement type ...	58
Setting the Sports Team Display	58

iPod® (Optional)

Playback	58
Searching for a desired Song	59
Searching by artist name	59
Direct Search Function	59
Selecting Playlist/Artist/Album/Genre/ Composer/Podcast	59
Random Play Shuffle (M.I.X.)	60
Repeat Play	60

Remote Control

Controls on Remote Control	60
When Using the Remote Control	62
Battery Replacement	62

Information

About DVDs	63
Terminology	64
List of Language Codes	65
List of Country Codes	66
In Case of Difficulty	68
Specifications	72

Installation and Connections

Warning	73
Caution	73
Precautions	73
Installation	74
Connections	76
System Example	78

LIMITED WARRANTY

Operating Instructions

WARNING



WARNING

This symbol means important instructions. Failure to heed them can result in serious injury or death.

INSTALL THE PRODUCT CORRECTLY SO THAT THE DRIVER CANNOT WATCH TV/VIDEO UNLESS THE VEHICLE IS STOPPED AND THE EMERGENCY BRAKE IS APPLIED.

It is dangerous (and illegal in many states) for the driver to watch TV/Video while driving a vehicle. Installing this product incorrectly enables the driver to watch TV/Video while driving. This may cause a distraction, preventing the driver from looking ahead, thus causing an accident. The driver or other people could be severely injured.

DO NOT WATCH VIDEO WHILE DRIVING.

Watching the video may distract the driver from looking ahead of the vehicle and cause an accident.

DO NOT OPERATE ANY FUNCTION THAT TAKES YOUR ATTENTION AWAY FROM SAFELY DRIVING YOUR VEHICLE.

Any function that requires your prolonged attention should only be performed after coming to a complete stop. Always stop the vehicle in a safe location before performing these functions. Failure to do so may result in an accident.

KEEP THE VOLUME AT A LEVEL WHERE YOU CAN STILL HEAR OUTSIDE NOISES WHILE DRIVING.

Excessive volume levels that obscure sounds such as emergency vehicle sirens or road warning signals (train crossings, etc.) can be dangerous and may result in an accident. LISTENING AT LOUD VOLUME LEVELS IN A CAR MAY ALSO CAUSE HEARING DAMAGE.

MINIMIZE DISPLAY VIEWING WHILE DRIVING.

Viewing the display may distract the driver from looking ahead of the vehicle and cause an accident.

DO NOT DISASSEMBLE OR ALTER.

Doing so may result in an accident, fire or electric shock.

USE ONLY IN CARS WITH A 12 VOLT NEGATIVE GROUND.

(Check with your dealer if you are not sure.) Failure to do so may result in fire, etc.

KEEP SMALL OBJECTS SUCH AS BATTERIES OUT OF THE REACH OF CHILDREN.

Swallowing them may result in serious injury. If swallowed, consult a physician immediately.

USE THE CORRECT AMPERE RATING WHEN REPLACING FUSES.

Failure to do so may result in fire or electric shock.

DO NOT BLOCK VENTS OR RADIATOR PANELS.

Doing so may cause heat to build up inside and may result in fire.

USE THIS PRODUCT FOR MOBILE 12V APPLICATIONS.

Use for other than its designed application may result in fire, electric shock or other injury.

DO NOT PLACE HANDS, FINGERS OR FOREIGN OBJECTS IN INSERTION SLOTS OR GAPS.

Doing so may result in personal injury or damage to the product.



CAUTION

This symbol means important instructions. Failure to heed them can result in injury or material property damage.

HALT USE IMMEDIATELY IF A PROBLEM APPEARS.

Failure to do so may cause personal injury or damage to the product. Return it to your authorized Alpine dealer or the nearest Alpine Service Center for repairing.

KEEP FINGERS AWAY WHILE THE MOTORIZED FRONT PANEL OR MOVING MONITOR IS IN MOTION.

Failure to do so may result in personal injury or damage to the product.

DO NOT MIX NEW BATTERIES WITH OLD BATTERIES. INSERT WITH THE CORRECT BATTERY POLARITY.

When inserting the batteries, be sure to observe proper polarity (+ and -) as instructed. Rupture or chemical leakage from the battery may cause fire or personal injury.

PRECAUTIONS

Product Cleaning

Use a soft dry cloth for periodic cleaning of the product. For more severe stains, please dampen the cloth with water only. Anything else has the chance of dissolving the paint or damaging the plastic.

Temperature

Be sure the temperature inside the vehicle is between +45°C (+113°F) and 0°C (+32°F) before turning your unit on.

Moisture Condensation

You may notice the disc playback sound wavering due to condensation. If this happens, remove the disc from the player and wait about an hour for the moisture to evaporate.

Damaged Disc

Do not attempt to play cracked, warped, or damaged discs. Playing a bad disc could severely damage the playback mechanism.

Maintenance

If you have problems, do not attempt to repair the unit yourself. Return it to your Alpine dealer or the nearest Alpine Service Station for servicing.

Never Attempt the Following

Do not grip or pull out the disc while it is being pulled back into the player by the automatic reloading mechanism.

Do not attempt to insert a disc into the unit when the unit power is off.

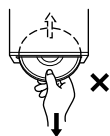

Inserting Discs

Your player accepts only one disc at a time for playback. Do not attempt to load more than one disc.

Make sure the label side is facing up when you insert the disc. "DISC ERROR" will be displayed on your player if you insert a disc incorrectly. If "DISC ERROR" continues to be displayed even though the disc has been inserted correctly, push the RESET switch with a pointed object such as a ballpoint pen.

Playing a disc while driving on a very bumpy road may result in skips, but this will not scratch the disc or damage the player.

Irregular Shaped Discs

Be sure to use round shaped discs only for this unit and never use any special shaped discs.

Use of special shaped discs may cause damage to the mechanism.



New Discs

To prevent the CD from jamming, "DISC ERROR" is displayed if discs with irregular surfaces are inserted or if discs are inserted incorrectly. When a new disc is ejected immediately after initial loading, use your finger to feel around the inside of the center hole and outside edge of the disc. If you feel any small bumps or irregularities, this could inhibit proper loading of the disc. To remove the bumps, rub the inside edge of the hole and outside edge of the disc with a ballpoint pen or other such instrument, then insert the disc again.

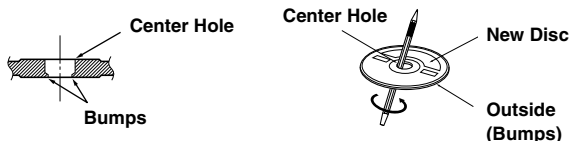

Installation Location

Make sure the IVA-D105 will not be installed in a location subjected to:

- Direct sun and heat
- High humidity and water
- Excessive dust
- Excessive vibrations

Correct Handling

Do not drop the disc while handling. Hold the disc so you will not leave fingerprints on the surface. Do not affix tape, paper, or gummed labels to the disc. Do not write on the disc.

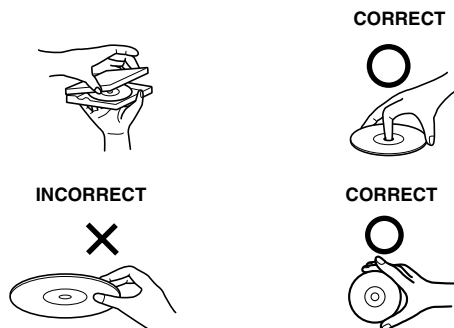

Disc Cleaning

Fingerprints, dust, or soil on the surface of the disc could cause the DVD player to skip. For routine cleaning, wipe the playing surface with a clean, soft cloth from the center of the disc to the outer edge. If the surface is heavily soiled, dampen a clean, soft cloth in a solution of mild neutral detergent before cleaning the disc.



Disc Accessories

There are various accessories available on the market for protecting the disc surface and improving sound quality. However, most of them will influence the thickness and/or diameter of the disc. Using such accessories can cause operational problems. We recommend not using these accessories on discs played in Alpine DVD players.

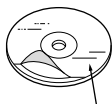

Transparent Sheet

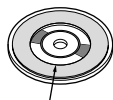

Disc Stabilizer

Handling the Detachable Front Panel

- Do not expose to rain or water.
 - Do not drop or subject to shock.
-
- After turning the system off, a slight ghost of the image will remain temporarily. This is an effect peculiar to LCD technology and is normal.
 - In cold temperature conditions, the screen may lose contrast temporarily. After a short warm-up period, it will return to normal.

Alpine products equipped with the Ai-NET bus, connected to the IVA-D105, can be operated from the IVA-D105. Depending on the products connected, the functions and displays will vary. For details, consult your Alpine dealer.

Operation of some of the functions of this unit is very complex. Because of this, it was deemed necessary to place these functions into a special screen. This will restrict operation of these functions to times when the vehicle is parked. This ensures the focus of the driver's attention will be on the road and not on the IVA-D105. This has been done for the safety of the driver and passengers. Audio Processor Adjustments cannot be made if the car is moving. The car must be parked and the parking brake must be engaged for the procedure described in the Owner's Manual to be valid. The warning "CAN'T OPERATE WHILE DRIVING," will be displayed if any attempts are made to perform these operations while driving.

- The IVA-D105 draws minimal current even when its power switch is turned off. If the switched power (ignition) lead of the IVA-D105 is connected directly to the positive (+) post of the vehicle's battery, the battery may be discharged. An SPST (Single-Pole, Single-Throw) switch (sold separately) can be added to simplify this procedure. Then, you can simply place it in the OFF position when you leave the vehicle. Turn the SPST switch back ON before using the IVA-D105. For connecting the SPST switch, refer to the "Connection Diagram of SPST Switch (Sold Separately)" (page 75). If the power (ignition) lead is unswitched, it must be disconnected from the battery post should the vehicle be left unused for an extended period of time.

Discs Playable on This Unit

Playable Discs

The discs listed below can be played on this unit.

	Mark (logo)	Recorded content	Disc size
DVD Video		Audio + Video	12 cm*
			8 cm
DVD Audio		Audio + Video	12 cm*
			8 cm
Video CD		Audio + Video	12 cm
			8 cm
Music CD		Audio	12 cm
			8 cm (CD single)

* Two-layer DVD disc compatible

Discs that cannot be played

DVD-ROMs, DVD-RAMs, CD-ROMs (excluding MP3/WMA/AAC files), photo CDs, etc.

DualDisc

This unit is not compatible with DualDisc.

Using a DualDisc may cause unit malfunction, and may cause disc damage when the disc is inserted/ejected.

DVD region number (playable region number)

This DVD player will play back any disc whose region number is 1 (or All). DVDs with a region number other than those listed below, cannot be played on this DVD player.



Video CDs

This DVD head unit is compatible with playback control (PBC) compatible Video CDs (version 2.0).

“PBC” is a function by which you can use menu screens recorded on the disc to find the scene you want to watch and view various types of information in dialog style.

Using compact discs (CD/CD-R/CD-RW)

If you use unspecified compact discs, correct performance cannot be guaranteed.

You can play CD-Rs (CD-Recordable)/CD-RWs (CD-ReWritable) which have been recorded only on audio devices. You can also play CD-Rs/CD-RWs containing MP3/WMA/AAC formatted audio files.

- Some of the following discs may not play on this unit:
Flawed discs, discs with fingerprints, discs exposed to extreme temperatures or sunlight (e.g., left in the car or this unit), discs recorded under unstable conditions, discs on which a recording failed or a re-recording was attempted, copy-protected CDs which do not conform to the audio CD industry standard.
- Use discs with MP3/WMA/AAC files written in a format compliant with this unit. For details, see pages 17 and 18.

To customers using CD-R/CD-RW

- If a CD-R/CD-RW cannot be played back, make sure the last recording session was closed (finalized).
 - Finalize the CD-R/CD-RW if necessary, and attempt playback again.
-

Tips for making your own CDs

The IVA-D105 plays DVD Video, DVD Audio, Video CD, Audio CD, DivX[®] and has a built in MP3/WMA/AAC decoder.

The following information is designed to help you create your own music CDs (either Audio CD or MP3/WMA/AAC encoded CD-R/RW files).

What is the difference between an Audio and MP3/WMA/AAC CD?

An Audio CD is the same format as the commercial CDs you buy in the store (also known as CD-DA). MP3 (MPEG-1 Audio Layer 3)/WMA (Windows Media Audio)/AAC (Advanced Audio Coding) is a data file that uses a compression scheme to reduce the size of the music file.*

Hybrid Audio CD and Data (MP3/WMA/AAC) CD-R/RW discs:

The IVA-D105 can read either sector on the disc. Choose CD-DA to play the CD audio section or MP3/WMA/AAC to play the MP3/WMA/AAC section.*

Multisession CD-R/RW:

Once a recording has been stopped, this is considered one session. If the disc is not closed (finalized), additional data may be added. Once this additional data has been recorded, this becomes a “multisession” CD. The IVA-D105 can only read multisession DATA Formatted discs (MP3/WMA/AAC files - Not Audio CD files).

Properly formatted MP3/WMA/AAC Discs:

Use ISO9660 formatting to insure proper playback. You may use standard ISO naming Level 1 (8.3 DOS standard), Level 2 (32 characters) or Joliet (Windows or Macintosh long filenames) file naming conventions*.

*Please consult the Owner’s manual for additional information.

On handling compact discs (CD/CD-R/CD-RW)

- Do not touch the surface.
- Do not expose the disc to direct sunlight.
- Do not affix stickers or labels.
- Clean the disc when it is dusty.
- Make sure that the disc is smooth and flat.
- Do not use commercially available disc accessories.

Do not leave the disc in the car or the unit for a long time. Never expose the disc to direct sunlight.

Heat and humidity may damage the disc and you may not be able to play it again.

Using DVD-Rs/DVD-RWs/DVD+Rs/DVD+RWs

- This unit is compatible discs recorded in the DVD-Video and DVD-VR, DivX[®] mode.
- Note that discs not finalized (processed to enable to play on playback-only DVD players) cannot be played on this DVD player.
- Some discs may not play back, depending on the recording device and disc format.
- Discs or files utilizing copy protection, may not be playable. Some recording systems may not properly format copied files to enable proper playback.
- In the following cases, the disc may not play on this unit: discs recorded by certain DVD recorders, certain irregular discs, flawed discs, dirty discs, when the pickup lens of this DVD player is dirty, or when moisture condensation has occurred inside the unit.
- Be sure to follow all cautions included with your DVD-Rs/DVD-RWs/DVD+Rs/DVD+RWs discs.
- Do not put stickers, seals, or tape on the label side of DVD-Rs/DVD-RWs/DVD+Rs/DVD+RWs.
- Compared to the regular discs, DVD-Rs/DVD-RWs/DVD+Rs/DVD+RWs are more affected by heat, moisture, and direct sunlight. If left in a car, etc., damage may occur and it might not play on this unit.
- The operable temperature range for disc playback is as follows:
DVD-R/DVD-RW: -25 ~ +70°C
DVD+R/DVD+RW: +5 ~ +55°C

Disc terminology

Title

If titles are programmed for the DVD, these are the largest units of division of the information recorded on the disc.

Chapter

Each Title may also be divided into smaller divisions, called chapters. These can be specific scenes or musical selections.

- *This product incorporates copyright protection technology that is protected by U.S. patents and other intellectual property rights. Use of this copyright protection technology must be authorized by Macrovision, and is intended for home and other limited viewing uses only unless otherwise authorized by Macrovision. Reverse engineering or disassembly is prohibited.*
- *Manufactured under license from Dolby Laboratories. "Dolby," "Pro Logic" and the double-D symbol are trademarks of Dolby Laboratories.*
- *"DTS" and "DTS Digital Surround" are registered trademarks of DTS, Inc.*
- *Windows Media and the Windows logo are trademarks, or registered trademarks of Microsoft Corporation in the United States and/or other countries.*
- *Apple, the Apple logo and iPod, and iTunes are trademarks of Apple Computer, Inc., registered in the U.S. and other countries.*
- *HD Radio™ Technology Manufactured Under License From iBiquity Digital Corporation. iBiquity Digital and the HD Radio and HD Symbols are trademarks of iBiquity Digital Corporation. U.S. and Foreign Patents.*
- *"MPEG Layer-3 audio coding technology licensed from Fraunhofer IIS and Thomson"*
- *"Supply of this product only conveys a license for private, non-commercial use and does not convey a license nor imply any right to use this product in any commercial (i.e. revenue-generation) real time broadcasting (terrestrial, satellite, cable and/or any other media), broadcasting/streaming via internet, intranets and/or other networks or in other electronic content distribution systems, such as pay-audio or audio-on-demand applications. An independent license for such use is required. For details, please visit <http://www.mp3licensing.com>"*

Getting Started

Accessory List

• Head unit	1
• Power Cable	1
• Pre OUT/AUX cable.....	1
• Mounting Sleeve.....	1
• Mounting Bracket	2
• Flush Head screw (M4 x 3).....	8
• Hexagon washer-head screw (M4 x 6).....	4
• Front Frame	1
• Remote Control	1
• Battery (CR2025).....	1
• Carrying bag	1
• Owner's Manual	1 set

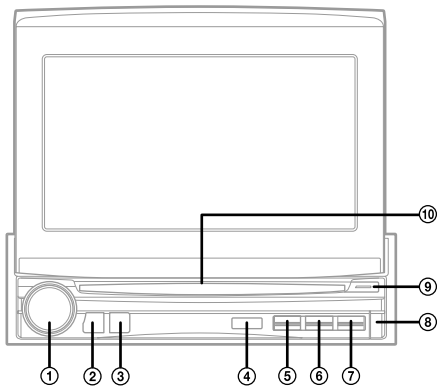

Connectable to Remote Control Interface Box

You can operate this unit from the vehicle's control unit when an Alpine Remote Control Interface Box (optional) is connected. For details, contact your Alpine dealer.

Location of Controls

- ① Rotary encoder/MUTE/AUDIO**
Adjust the volume by turning to the left or right.
Turns the Mute mode on or off by pressing repeatedly.
If pressed and held for at least 2 seconds, the audio setup screen is displayed.
- ② SOURCE/⏻ button**
Turns the power on. Press and hold for at least 2 seconds to turn the power off.
Monitor open: Recalls the SOURCE selection screen.
Monitor closed: Changes the source.

- ③ BAND/SAT button**
Radio mode: Changes the band.
Visual source (except navigation screen): Changes the display mode.
Press this button for at least 2 seconds to recall a weather channel or traffic channel. Note however, this setting can be made only if the XM or SIRIUS Receiver Box is connected.
- ④ Remote Sensor**
Point the supplied remote control transmitter towards the remote sensor within a range of 2 meters.
- ⑤ VISUAL button**
Press and hold for at least 2 seconds to recall the VISUAL selection screen.
If VISUAL is set in "Setting the VISUAL Button" (page 38), momentarily press to recall the VISUAL selection screen, and if NAV. is set, momentarily press to recall the navigation screen.
- ⑥ OPEN/CLOSE/FLAT button**
Opens the monitor.
Closes the monitor by pressing and holding for at least 2 seconds.
Press to set the open monitor to the flat position.
- ⑦ ▲ button**
Ejects a disc.
- ⑧ ▽ button**
Use this button to remove the front panel.
- ⑨ DISC IN Indicator**
Lights up when a disc is inserted in the unit.
- ⑩ Power Indicator**
This indicator is lit when power is on.

About the expression of buttons in this Owner's Manual

- The buttons on this unit are expressed in bold (e.g. **SOURCE/⏻**). The touch buttons on the display are expressed in bold with [] (e.g. **[BAND]**).

Detaching and Attaching the Front Panel

Detaching

- 1 Turn off the unit power.
- 2 Press **▲** (Release) at the lower right side until the front panel pops out.
- 3 Grasp the right side of the front panel and pull it out.

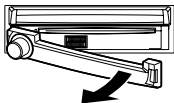

- The front panel may become hot in normal usage (especially the connector terminals on the back of the front panel). This is not a malfunction.
- To protect the front panel, place it in the supplied carrying bag.

Attaching

- 1 Insert the left side of the front panel into the main unit. Align the groove on the front panel with the projections on the main unit.
- 2 Push the right side of the front panel until it locks firmly into the main unit.

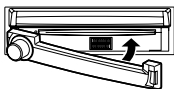

- Before attaching the front panel, make sure that there is no dirt or dust on the connector terminals and no foreign object between the front panel and the main unit.
- Attach the front panel carefully, holding the sides of the front panel to avoid pushing buttons by mistake.

Initial System Start-Up

Immediately after installing or applying power to the unit, it should be initialized. To do this, first, remove the detachable front panel. Behind the front panel, to the left of the connector, there is a small hole. Using a pencil or other pointed object, press the RESET switch mounted behind this hole to complete the initialization procedure.

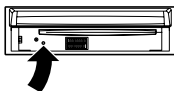

- Any of the buttons does not function while the monitor is closing by reset.

Turning Power On or Off

Some of this unit's functions cannot be performed while the vehicle is in motion. Be sure to stop your vehicle in a safe location and apply the parking brake, before attempting these operations.

- 1 Press **SOURCE/⏻** to turn on the unit.
 - The unit can be turned on by pressing any button on the unit except **OPEN/CLOSE**, **FLAT** and **▲** (Eject).
- 2 Press and hold **SOURCE/⏻** for at least 2 seconds to turn off the unit.
 - Some operation of the unit cannot be performed while the vehicle is in motion. In this case, be sure to first stop your vehicle and apply the parking brake, then perform the operation.

Opening/Closing the Monitor

- 1 Press **OPEN**.
The unit beeps 3 times and opens the monitor automatically.
 - 2 Press and hold **OPEN (CLOSE)** for at least 2 seconds.
The unit beeps 3 times and closes the monitor automatically.
- Opening/closing the monitor should never be performed manually. It may cause a malfunction.
 - The monitor's angle is set to 90 degrees at the factory. Depending on the car, the monitor may hit the dashboard when opened. The monitor's angle can be adjusted and stored in memory so that the monitor will not hit the dashboard when opening. For adjusting the monitor, refer to "Adjusting the Monitor Angle" on page 39. Even when the vehicle's battery power is removed, the adjusted monitor angle remains stored in memory.
 - The IVA-D105 is a precision device. With gentle handling, its unique capabilities can be enjoyed for a long time.
 - If the monitor touches anything while it is being opened (or closed), the monitor will stop opening (or closing) immediately. Should this occur, remove the obstacle and press and hold **OPEN** for at least 2 seconds again to lower the monitor.
 - When the movable monitor is opened, do not place any object on the monitor and be careful not to bump or apply any pressure to the monitor while it is open. This can cause damage to the mechanism.
 - In low ambient temperature conditions, the display may be dark for a short period of time immediately after the power is turned on. Once the LCD has warmed up, the display returns to normal.
 - For your safety, some operation of the unit cannot be performed while the vehicle is in motion. In this case, first stop the vehicle and engage the parking brake, then perform the operation.

Moving the Monitor to be Flat

When you want to operate some function on the car (air conditioner, etc.) which is hidden by the raised monitor, use this function.

1 When the monitor is open, press **OPEN (FLAT)**.

The monitor moves to the flat position.

2 Press **OPEN (FLAT)** again.

The monitor returns to the previous angle.

- The monitor returns to the previous angle 10 seconds after being moved to the flat position.
- If an excessive force is added to the monitor when the monitor is flat, putting an object on the back of the monitor for example, it may cause a malfunction.

Adjusting the Volume

Adjust the volume by turning the **Rotary encoder**.

Volume: 0 - 35

Lowering Volume Quickly

Activating this function will instantly lower the volume level by 20 dB.

Press **MUTE (Rotary encoder)** to activate the **MUTE mode**.

The audio level decreases by about 20 dB.

Pressing **MUTE (Rotary encoder)** again brings the audio back to its previous level.

How to view the Display

PULSETOUCH™ operation

The display unit is equipped with onscreen, tactile feedback (PULSETOUCH™).

What is the tactile feedback (PULSETOUCH™) ?

When you touch a button graphic in the display, you will feel a mild vibration and click on the display panel surface. This feedback enables you to easily identify action areas in the display.

- To protect the display, touch the onscreen button with the tip of your finger.
- If you touch a button and there is no reaction, remove your finger from the display once, and try again.
- If you touch two buttons at the same time, a malfunction may occur.

Onscreen buttons are expressed as follows in this Owner's Manual.

- Onscreen buttons are shown in bold, enclosed in [] (e.g. **[BAND]**).

Recalling the Source

Here is an example explanation for the Radio mode display on how to recall a source.

1 Press **SOURCE/⏻**.

The SOURCE selection screen is displayed.

Display example for SOURCE selection screen

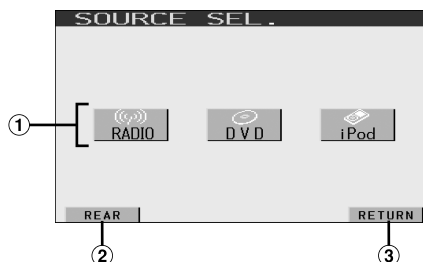

- ① Displays source modes that can be selected.
- ② Changes to the Rear Selection screen when "Setting the Picture/Sound Output" (page 38) is set to ON.
- ③ Returns to the previous screen.

- The kind of source modes that are displayed varies depending on connection and setting.
- When the source icon is not displayed on SOURCE Selection screen, it is displayed on the next page.
Touching **[NEXT]** on the SOURCE Selection Screen will display the next page; touching **[PREV.]** will return to the previous page.

2 Touch [RADIO].

The screen changes to the Radio mode main display.

Main screen example for FM Radio mode

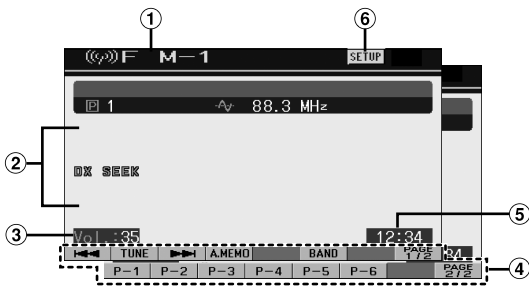

- ① Displays the source name, such as radio band, etc., that is selected
- ② Working state indicator
- ③ Displays volume level
- ④ Function Guide:
The function guide display varies depending on each source.
Touching [PAGE1/2]* or [PAGE1/3]* on the function guide will change the contents of the function guide, allowing for many other operations to be performed.
- ⑤ Displays time
- ⑥ Change to SETUP selection screen.

* Display may vary depending on the connected devices.

- When an optional DVD player or DVD changer compatible with Ai-NET is connected, AUX appears as "DVD" or "DVD-CHG" in the display.
- When both the optional DVD player and DVD changer compatible with Ai-NET are connected, AUX appears as "DVD" and DVD changer as "DVD-CHG" in the display.

3 Press SOURCE/⏻ on the unit to change the screen to another source.

- Pressing VISUAL on the unit will change to the VISUAL selection screen.
Set to VISUAL in "Setting the VISUAL Button" (page 38).

Displaying the Numeric Keypad Input Screen

The numeric keypad input screen is displayed when the DVD or Video CD mode is selected for searching a title or chapter, and for entering a country code or password for the DVD setup item, and also when selecting a channel number in the SAT Radio mode.

1 Touch [10KEY] on the main source screen.

2 Touch the desired numeric key.

Display example for numeric keypad

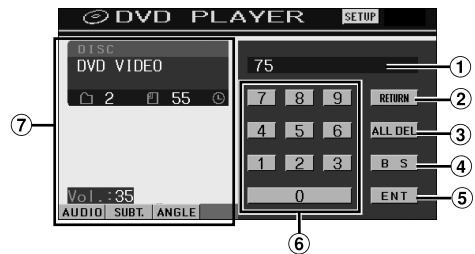

- ① Input screen area
- ② Closes numeric keypad input screen
- ③ All input numbers will be deleted
- ④ Previous number will be deleted
- ⑤ Input number is confirmed
- ⑥ Numeric keypad
- ⑦ The numeric keypad input screen closes when the area is touched while displayed.

3 Touch [ENT] to confirm your entry.

Radio

Display example for FM Radio main screen



- ① Displays the preset number/frequency.

This unit cannot receive HD Radio™ signals (digital terrestrial radio). In order to activate the digital radio functions described below, an optional HD Radio Tuner module must be connected through the Ai-NET bus.

Listening to the Radio

- 1 Press **SOURCE/⏻**.
The SOURCE selection screen is displayed.

Receiving Analog Radio:

- 2 Touch **[RADIO]**.
The radio mode is activated and the display changes to the Radio Mode screen.

Receiving HD Radio (if TUA-T500HD is connected):

- 2 Touch **[HD RADIO]**.
The digital radio mode is activated and the display changes to the HD Radio Tuner Mode screen.
- 3 Touch **[BAND]** to select the desired radio band.
Each press changes the bands as follows:

FM-1 → FM-2 → AM → FM-1

- 4 Touch **[TUNE]** to choose the tuning mode.
Each touch changes the tuning mode display.

Distance → Local → Manual → Distance

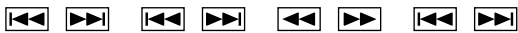

- There are two modes you can select for auto tuning, **DX** and **Local**:
 - **DX (Distance) mode (with DX SEEK indicator ON)**;
Both strong and weak stations will be tuned in.
 - **Local mode (with SEEK indicator ON)**;
Only strong stations will be tuned in.
The initial setting is **DX**.

- 5 Touch **[◀◀], [▶▶]** or **[◀], [▶]** to change the radio frequency up or down respectively.

In the manual mode, touch and hold to change the frequency continuously.

- “DIGITAL” is displayed when a digital radio station is received.
- Also refer to “Digital SEEK Setting” (page 34).

Manual Storing of Station Presets

- 1 Tune in a desired radio station you wish to store in the preset memory by manual or automatic seek tuning.
- 2 Touch **[PAGE1/2]*** to change the function guide.
- 3 Touch and hold any one of the preset buttons **[P-1]** through **[P-6]** for at least 2 seconds.
The selected station is stored.
- 4 Repeat the procedure to store up to 5 other stations onto the same band.

* “[PAGE 1/3]” is displayed in the HD Radio mode.

To use this procedure for other bands, simply select the band desired and repeat the procedure.

A total of 18 stations can be stored in the preset memory (6 stations for each band; FM1, FM2 and AM).

- If a preset memory has already been set in the same preset number, it will be cleared and the new station will be memorized.

Automatic Memory of Station Presets

The tuner can automatically seek and store 6 strong stations in the selected band in order of signal strength.

After selecting the desired band, touch **[A.MEMO]**.

The tuner automatically seeks and stores 6 strong stations into [P-1] to [P-6] in order of signal strength. When the automatic storing has been completed, the tuner goes to the station stored in [P-1].

- If no stations are stored, the tuner will return to the original station you were listening to before the automatic storing procedure began.

Tuning to Preset Stations

You can tune in the preset stations in memory on each band using the preset number.

- 1 After selecting the desired band, touch **[PAGE1/2]*** to change the function guide.

* “[PAGE 1/3]” is displayed in the HD Radio mode.

- 2 Touch any one of the preset buttons **[P-1]** through **[P-6]** that has a station stored to it.
The preset station is received.

Changing the Display (HD Radio mode only)

Text information, such as Station name, Song title, Artist, etc., is displayed while receiving a digital radio station.

1 Touch [INFO.] on the HD Radio Tuner mode main screen.

Each time you touch this button, the display changes as shown below.

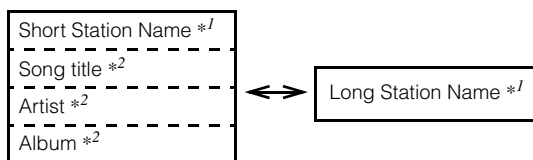

*1 Displays Short Station Name / Long Station Name in the Station Information Service Data.

*2 Displays Song title / Artist / Album in the main program Service Data.

Displaying a List of the Program (HD Radio mode only)

1 Touch [P1/3] twice in the HD Radio Tuner mode to change to the function guide.

2 Touch [INFO].

The program list is displayed.

3 Touch [▶] of the desired program type.

The selected program is received.

Receiving a Multicast (HD Radio mode only)

Multicasting, which is the ability to broadcast multiple program streams over a single FM frequency, thereby increasing the amount and diversity of content choices.

When the channel for the multicast radio station is received, the "MULTICAST" indicator lights.

1 Touch [P1/3] twice in the HD Radio Tuner mode to change to the function guide.

2 Touch [▼] or [▲] of PROGRAM.

The sub channel of the received radio station is changed.

CD/MP3/WMA/AAC

Display example for MP3/WMA main screen



① CD:

Displays track text*1 in the upper line.

Displays Disc Text/Artist *1 in the lower line.

- If there is neither Track nor Disc name information, "NO TEXT" will be displayed.

MP3/WMA/AAC:

After displaying the file name in the upper line, the track name is displayed if there is ID3 tag information.

After displaying the folder name in the lower line, the album name/artist name are displayed if there is ID3 tag information.

② CD:

Displays the disc number*2/track number/elapsed time.

MP3/WMA/AAC:

Displays the disc number*3/folder number/file number/ elapsed playback time

③ [INFO] button: Refer to page 27

*1 Displayed when a CD text disc is inserted.

*2 Displayed when a CD changer is connected.

*3 Displayed when an MP3 compatible CD changer is connected.

Playback

1 Press **SOURCE/⏻**.

The SOURCE selection screen is displayed.

2 Touch **[DVD]**.

The display shows the DVD player mode screen.

When a CD/MP3/WMA/AAC is inserted into the DISC SLOT of the IVA-D105, with the label side facing up, the unit starts to play the CD/MP3/WMA/AAC.

3 Touch **[◀◀◀]** or **[▶▶▶]** to select the desired track (file).

Returning to the beginning of the current track (file):

Touch **[◀◀◀]**.

Fast reverse :

Touch and hold **[◀◀◀]**.

Advancing to the beginning of the next track (file) :

Touch **[▶▶▶]**.

Fast forward :

Touch and hold **[▶▶▶]**.

To pause playback

Touch **[▶/||]**.

Touching **[▶/||]** again will resume playback.

To eject the disc

Press **▲**.

- If the disc does not eject, press and hold **▲** for at least 3 seconds.
- The IVA-D105 model includes a built-in MP3/WMA/AAC unit. You can play CD-ROMs, CD-Rs, and CD-RWs containing MP3/WMA/AAC files on this unit. Use the format compliant with this unit. For further information about playing or storing MP3/WMA/AAC files, refer to pages 17 and 18 before using the unit.
- WMA format files that are protected by DRM (Digital Rights Management), AAC format files that have been purchased from iTunes Music Store and files that are copy-protected (copyright protection) cannot be played back on this unit.
- The unit can play discs containing both audio data and MP3/WMA/AAC data.
- The MP3/WMA or AAC indicator is lit during MP3/WMA or AAC playback.
- The track display for CD audio data playback is the track numbers recorded on the disc.
- Three-inch (8cm) CD's can be used.
- "Playing MP3/WMA/AAC Data" is mentioned on page 34.
- When an MP3/WMA/AAC disc is played, it sometimes takes a few moment until it starts.
- Touch **[□]** to activate the search mode. For operations, refer to "Search Function" on page 27.
However, the search mode function does not work in the CD changer mode.
- The playback time may not be correctly displayed when a VBR (Variable Bit Rate) recorded file is played back.
- If the disc is left in the unit after pressing **▲**, the disc is automatically pulled back into the unit and paused. In this case, start playback by touching **[▶/||]** or eject again and remove the disc within 15 seconds.

Repeat Play

Touch **[↺]** to play back repeatedly the track currently being played.

The track (file) will be played repeatedly.

Touch **[↺]** again and select OFF to deactivate Repeat play.

CD: RPT → RPT DISC*¹ → (off) → RPT

MP3/WMA/AAC:

- 1 Touch **[PAGE1/2]***³ to change the function guide.
- 2 Touch **[↺]** and select the desired Repeat play.

RPT → RPT FLDR*² → RPT DISC*¹ → (off) → RPT

*¹ If a CD Changer or an MP3 compatible CD changer is connected and the RPT DISC mode is selected, the unit repeatedly plays back all tracks (files) on the disc selected.

*² Only files in a folder are repeatedly played back.

*³ Display may vary depending on the connected devices.

M.I.X. (Random Play)

Touch **[∞]** during playback.

The tracks (files) on the disc will be played back in a random sequence.

To cancel M.I.X. play, touch **[∞]**.

CD: M.I.X. → M.I.X. ALL*¹ → (off) → M.I.X.

MP3/WMA/AAC:

- 1 Touch **[PAGE1/2]***⁴ to change the function guide.
- 2 Touch **[∞]** and select the desired M.I.X. play.

M.I.X. FLDR*³ → M.I.X.*² → (off) → M.I.X. FLDR*³

*¹ If a CD Changer equipped with the M.I.X. ALL function is connected, M.I.X. ALL will also be selectable.

In this mode, the tracks on all the CDs in the current magazine will be included in the random playback sequence.

*² If an MP3 compatible CD changer is connected, all files in a disc are played back in random sequence, and playback shifts to the next disc.

*³ Only files in a folder are played back in random sequence in the M.I.X. FLDR mode.

*⁴ Display may vary depending on the connected devices.

Selecting Folders (concerning MP3/WMA/AAC)

Touch **[▼ FLDR]** or **[FLDR ▲]** to select the folder.

About MP3/WMA/AAC

CAUTION

Except for private use, duplicating audio data (including MP3/WMA/AAC data) or distributing, transferring, or copying it, whether for free or for a fee, without permission of the copyright holder is strictly prohibited by the Copyright Act and by international treaty.

What is MP3?

MP3, whose official name is "MPEG-1 Audio Layer 3," is a compression standard prescribed by the ISO, the International Standardization Organization and MPEG which is a joint activity institution of the IEC.

MP3 files contain compressed audio data. MP3 encoding is capable of compressing audio data at extremely high ratios, reducing the size of music files to as much as one-tenth their original size. This is achieved while still maintaining near CD quality. The MP3 format realizes such high compression ratios by eliminating the sounds that are either inaudible to the human ear or masked by other sounds.

What is WMA?

WMA, or "Windows media™ Audio," is compressed audio data. WMA is similar to MP3 audio data and can achieve CD quality sound with small file sizes.

What is AAC?

AAC is the abbreviation for "Advanced Audio Coding," and is a basic format of audio compression used by MPEG2 or MPEG4.

Method for creating MP3/WMA/AAC files

Audio data is compressed using software with MP3/WMA/AAC codecs. For details on creating MP3/WMA/AAC files, refer to the user's manual for that software.

MP3/WMA/AAC files that are playable on this device have the file extensions.

MP3: ".mp3"

WMA: ".wma" (ver. 2, 7, 8, 9 are supported, however PRO, VOICE, LOUDNESS are not supported)

AAC: ".m4a"

There are many different versions of the AAC format. Confirm that the software being used conforms to the acceptable formats listed above. It's possible that the format may be unplayable even though the extension is valid.

Playback of AAC files encoded by iTunes version 4.8 or earlier is supported.

Supported playback sampling rates and bit rates

MP3

Sampling rates: 48 kHz, 44.1 kHz, 32 kHz, 24 kHz, 22.05 kHz, 16 kHz, 12 kHz, 11.025 kHz, 8 kHz

Bit rates: 8 - 320 kbps

WMA

Sampling rates: 48 kHz, 44.1 kHz, 32 kHz, 22.05 kHz, 16 kHz, 11.025 kHz, 8 kHz

Bit rates: 8 - 320 kbps

AAC

Sampling rates: 48 kHz, 44.1 kHz, 32 kHz, 24 kHz, 22.05 kHz, 16 kHz, 11.025 kHz

Bit rates: 16 - 320 kbps

This device may not play back correctly depending on sampling rates.

With low level sampling or bit rates set, playback may not function correctly or sound quality may deteriorate. It is recommended to create a disc using as high a level sampling or bit rate as possible, within the range that playback is possible.

ID3 tags/WMA tags

This device supports ID3 tag v1 and v2, and WMA tag. If tag data is in an MP3/WMA/AAC file, this device can display the title (track title), artist name, and album name ID3 tag/WMA tag data (maximum 128 characters).

This device can only display single-byte alphanumeric characters and the underscore. For non-supported characters, "NO SUPPORT" is displayed.

The number of characters may be limited, or not correctly displayed, depending on the tag information.

Producing MP3/WMA/AAC discs

MP3/WMA/AAC files are prepared, then written to a CD-R or CD-RW (DVD-R/DVD-RW) using CD-R writing software. A disc can hold up to 4096 files/256 folders (including Root Folders). Depending on the folder/file structure of the disc, it can take several minutes to read a disc. In this case, it is recommended to reduce the number of folders used.

Media supported

The media that this device can play back are CD-ROMs, CD-Rs, CD-RWs, DVD-Rs and DVD-RWs.

Corresponding File Systems

This device supports discs formatted with ISO9660 Level 1 or Level 2.

Under the ISO9660 standard, there are some restrictions to remember.

The maximum nested folder depth is 8 (including the root directory). The number of characters for a folder/file name is limited.

Valid characters for folder/file names are letters A-Z (all caps), numbers 0-9, and '_' (underscore).

This device also can play back discs in Joliet, etc., and other standards that conform to ISO9660. However, sometimes the file names, folder names, etc., are not displayed correctly.

Formats supported

This device supports CD-ROM, CD-ROM XA, Mixed Mode CD, Enhanced CD (CD-Extra) and Multi-Session.

This device cannot correctly play back discs recorded with Track At Once or packet writing.

Order of files

Files are played back in the order that the writing software writes them to the disc. Therefore, the playback order may not be what's expected. Verify the writing order in the software's documentation. The playback order of the folders and files is as follows.

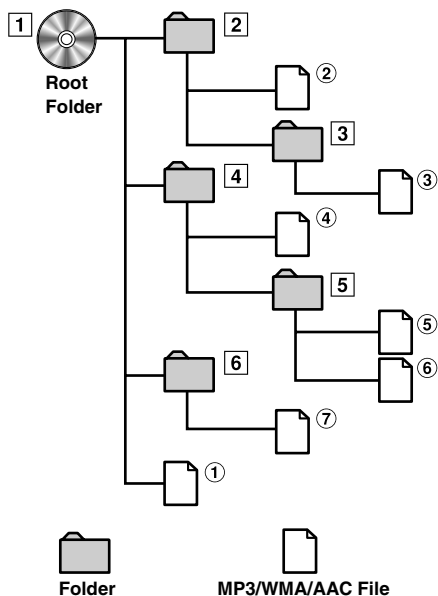

Terminology

Bit rate

This is the “sound” compression rate specified for encoding. The higher the bit rate, the higher the sound quality, but also the larger the files.

Sampling rate

This value shows how many times per second the data is sampled (recorded). For example, music CDs use a sampling rate of 44.1 kHz, so the sound is sampled (recorded) 44,100 times per second. The higher the sampling rate, the higher the sound quality, but also the larger the volume of data.

Encoding

Converting music CDs, WAVE (AIFF) files, and other sound files into the specified audio compression format.

Tag

Song information such as track titles, artist names, album names, etc., written into MP3/WMA/AAC files.

Root folder

The root folder (or root directory) is found at the top of the file system. The root folder contains all folders and files. It is created automatically for all burned discs.

DVD/Video CD

Display example for DVD Video main screen



- ① Displays the disc (DVD VIDEO, DVD AUDIO, PROGRAM/PLAYLIST (DVD-VR), VIDEO CD) being played back.
Displays tag information for DivX®.
 - ② Displays the title number/chapter number/elapsed playback time for a DVD Video.
Displays the group number/track number/elapsed playback time for a DVD Audio.
Displays the program or playlist number/chapter number/elapsed playback time for a DVD-VR.
Displays the track number/elapsed playback time for a Video CD (When PBC is turned off).
Displays the folder number/file number/elapsed playback time for a DivX®.
- If [] on the DivX® mode screen is touched, the search list screen is displayed. Refer to "Search Function" (page 27).
 - Some operations cannot be carried out depending on the disc or playback screen.
 - Displays of the function guide [PAGE1/2], etc., may vary depending on the connected device(s).

Disc types that can be used for each heading are represented by the following marks.

- DVD-V** DVD Commercial Video discs (used for the distribution of movies, etc.) or a DVD-R/DVD-RW, DVD+R/DVD+RW recorded in a video mode can be used.
(including discs containing both DVD video and DVD audio data that are played back when "VIDEO" is set in "Setting the DVD-Audio Playback Mode" (page 33).
- DVD-A** DVD Commercial Audio discs can be used.
- DVD-VR** DVD-R/DVD-RW discs recorded in DVD-VR mode can be used.
- V CD** Video-CD discs can be used.
- DivX** CD-R/CD-RW/DVD-R/DVD-RW/DVD+R/DVD+RW discs that are recorded in the DivX® mode can be used.

Playing a Disc

DVD-V DVD-A DVD-VR V CD DivX

IVA-D105 has a built-in DVD player. When an optional Alpine DVD/Video CD/CD player (or DVD changer) is connected to the IVA-D105, you can control it from the IVA-D105. (except some operations)

⚠ WARNING

It is dangerous (and illegal in many states) for the driver to watch the DVD/TV/Video while driving the vehicle. The driver may be distracted from looking ahead and an accident could occur.

Install the IVA-D105 correctly so that the driver cannot watch DVD/TV/Video unless the vehicle is stopped and the emergency brake is applied.

If the IVA-D105 is not installed correctly, the driver will be able to watch the DVD/TV/Video while driving the vehicle and may be distracted from looking ahead causing an accident. The driver or other people could be severely injured.

To display the DVD mode screen

DVD-V DVD-A DVD-VR V CD DivX

To watch a video source, your vehicle must be parked with the ignition key in the ACC or ON position. To do this, follow the procedure below.

- 1 Push the foot brake to bring your vehicle to a complete stop at a safe location. Engage the parking brake.
- 2 Keep pushing the foot brake and release the parking brake once then engage it again.
- 3 While the parking brake is being engaged the second time, release the foot brake.

- For automatic transmission vehicles, place the transmission lever in the Park position.

Now, the locking system for the DVD mode operation has been released. Engaging the parking brake can reactivate the DVD mode, as long as the car's ignition has not been turned off. It is not necessary to repeat the above procedure (1 through 3), of "To display the DVD mode screen."

Each time the ignition is turned OFF, perform the procedure of "To display the DVD mode screen."

- If you try to activate the auxiliary device while driving, the display will show the warning-PICTURE OFF FOR YOUR SAFETY.

⚠ Caution

- **Not all functions will operate for every DVD. See the individual DVD's instructions for details on the features supported.**
- **Fingerprints on a disc may adversely affect playback. If a problem occurs, remove the disc and check for fingerprints on the playback side. Clean the disc if necessary.**
- **If you switch the power or Ignition Key OFF or change sources during playback, playback will continue where you left off when you resume playback.**
- **If you try to perform an invalid operation (based on the type of disc being played), the following mark is displayed on the monitor screen: ⊘**

• Play Position Memory Function

Even if you turn power off or switch the Ignition Key to OFF during playback or change the source, playback will continue from the point where playback stopped when the power is turned ON again.

1 Press SOURCE/⏻.

The SOURCE selection screen is displayed.

2 Touch [DVD].

The display shows the DVD player mode screen.

Insert a disc with the label side facing up. The unit starts to play the disc.

When an optional Alpine DVD player is connected:

Insert a disc into the DVD/Video CD/CD player, the player starts playing.

- *The operation screen changes to the visual screen in the DVD or Video CD mode for 5 seconds after an operation has been performed. Touch the display panel to display the operation screen again.*
- *The display mode can be changed by touching [WIDE]. For operation, see "Switching Display Modes" on page 28.*

To eject the disc

Press ▲.

- *The reverse side of a double-sided DVD will not be played automatically. Remove the disc, turn it over, and reinsert it.*
- *If the disc does not eject, press and hold ▲ for at least 3 seconds.*
- *Do not insert discs containing maps for the navigation system. Doing so could result in damage.*
- *Refer also to "DVD Setup" (pages 29 to 34).*
- *Be sure the remote input lead is connected to the remote output lead of this unit when a DVD changer or DVD player is connected. If not correctly connected, touch operation cannot be performed.*
- *To return to the previous screen during Video CD playback, touch [RTN] after touching [PAGE1/2] of the function guide. However, the function may vary depending on the disc.*
- *If the disc is left in the unit after pressing ▲, the disc is automatically pulled back into the unit and stopped. In this case, start playback by touching [▶/||] or eject again and remove the disc within 15 seconds.*
- *While "INDEX READING" is displayed by DivX®, the fast-forwarding/fast-reversing and repeat functions, etc. cannot be used.*

If a menu screen appears

On DVDs and Video CDs with playback control (PBC), menu screens may appear automatically. If this happens, perform the operation described below to start playback.

- *To play back a DVD-Audio disc, set "VCAP" in "Setting the DVD-Audio Playback Mode" (page 33).*

Direct Menu Operations DVD-V DVD-A

1 Touch the DVD menu directly.

- *Some operations cannot be performed depending on the disc.*

Menu Operations DVD-V DVD-A



1 Touch [KEY].

The menu operation mode will be displayed.

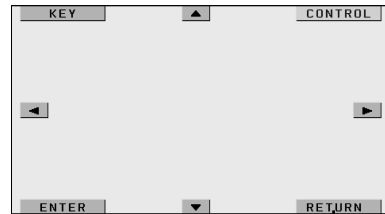

Touch [RETURN] to return to the previous display. (Operation may not be possible, depending on the disc.)

2 Select a desired menu item by touching [▲], [▼], [◀] or [▶].

3 Touch [ENTER] to confirm the selected item.

Numeric Keypad Input Operations (DVD-V) (DVD-A)



- 1 Touch **[KEY]**.
The menu operation mode appears.
- 2 Touch **[KEY]** again.
The numeric keypad input mode screen appears.

The numeric keypad input screen closes when the area is touched while displayed.

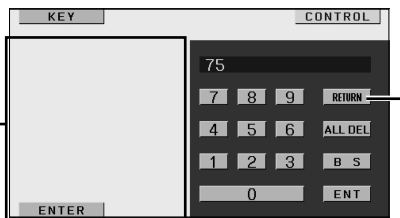

Touch **[RETURN]** to close the numeric keypad input screen.

- 3 Touch a desired number.
- 4 Touch **[ENT]** on the numeric keypad mode screen to confirm your selection.

Numeric Keypad Input Operations (VCD)

When PBC is turned OFF, the menu screen is not displayed. Turn it ON to display the screen (See "Setting the Video CD Play Mode" on page 34).

- 1 Touch **[PAGE1/2]** in the Video CD mode to change the function guide.
- 2 Touch **[10KEY]**.
The numeric keypad is displayed.
- 3 Touch and input a desired number.
- 4 Touch **[ENT]** to confirm.

Displaying the Top Menu Screen

(DVD-V) (DVD-A)

When a DVD contains two or more titles, the top menu screen appears.

Touch **[TOP MENU]** on the DVD mode main screen.
The top menu screen appears.

- To perform necessary operations, see "If a menu screen appears" on pages 20 and 21.
- To play back a DVD-Audio disc, set "VCAP" in "Setting the DVD-Audio Playback Mode" (page 33).

Displaying the Menu Screen (DVD-V)

With a DVD having two or more menus, a menu screen will appear for the programs available, in addition to the main programs.

Touch **[MENU]** on the DVD mode main screen.
The menu screen appears.

- To perform necessary operations, see "If a menu screen appears" on pages 20 and 21.

Displaying the Menu Operation Mode Screen (DVD-V) (DVD-A)

- 1 Touch **[PAGE1/2]*** on the DVD mode main screen.
The function guide changes.
* The display differs, depending on the disc (mode).

- 2 Touch **[MENU CONT]**.
The menu operation mode screen appears.

- For further operation, see "If a menu screen appears" on pages 20 and 21.
- To play back a DVD-Audio disc, set "VCAP" in "Setting the DVD-Audio Playback Mode" (page 33).

Searching by Program (DVD-VR)

- 1 Touch **[TOP MENU]** on the DVD mode main screen while playing a DVD-VR disc.
The program search list screen is displayed.
- 2 Touch **[▶]** of the program you want to play.
The selected program is played back, and then returns to the DVD mode main screen.

Searching by Playlist (DVD-VR)

- 1 Touch **[MENU]** on the DVD mode main screen while playing DVD-VR disc.
The playlist search list screen is displayed.
 - 2 Touch **[▶]** of the playlist you want to play.
The selected playlist is played back, and then returns to the DVD mode main screen.
- Only discs containing a Playlist can be operated.

Stopping Playback (PRE STOP)

(DVD-V) (DVD-A) (DVD-VR) (VCD) (DivX)

Press the stop button during playback to stop playback. That position is stored in the memory.

- 1 Touch **[■]** once during playback.
"PRE STOP" is displayed.
 - 2 Touch **[▶/||]** in the PRE STOP mode.
Playback starts from the position at which it was stopped.
- For some discs, the position at which playback was stopped may not be accurate.
 - To play back a DVD-Audio disc, set "VCAP" in "Setting the DVD-Audio Playback Mode" (page 33).

Stopping Playback

DVD-V DVD-A DVD-VR V CD DivX

Touch [■] twice or touch and hold [■] for at least 2 seconds during playback.

“STOP” is displayed, and playback stops.

- Playback starts from the beginning when [▶/||] is touched while playback is stopped.

Fast-forwarding/Fast-reversing

DVD-V DVD-A DVD-VR V CD DivX

DVD-Video, DVD-VR, Video-CD, DVD-Audio (VCAP mode)*, DivX®:

1 During playback, touch and hold [◀◀] (Fast-reverse) or [▶▶] (fast-forward).

When touched and held for more than 1 second, the disc is forwarded/reversed at double speed. When held for 5 more seconds or longer, the disc is forwarded/reversed at 8 times the normal speed. When held for 10 seconds or longer, the disc is forwarded/reversed at 21 times the normal speed.

DVD-Audio (VOFF mode)*:

1 During playback, touch and hold [◀◀] (Fast-reverse) or [▶▶] (fast-forward).

2 Stop touching [◀◀] or [▶▶] to return to normal playback.

* When “VCAP” or “VOFF” is set in “Setting the DVD-Audio Playback Mode” (page 33).

- No sound is played back during fast-forwarding/fast-reversing.
- For DVDs and Video CDs with playback control (PBC), the menu screen may reappear during fast-forwarding/fast-reversing.
- Operation may not be possible, depending on the disc.

Finding the Beginnings of Chapters/Tracks/Files

DVD-V DVD-A DVD-VR V CD DivX

During playback, touch [◀◀] or [▶▶].

The chapter/track/file switches each time the button is touched, and playback of the selected chapter/track/file starts.

▶▶: Touch this to start playback from the beginning of the following chapter, track or file.

◀◀: Touch this to start playback from the beginning of the current chapter, track or file.

- Some DVDs do not have chapters.
- Be sure to turn PBC off before starting the search (see “Setting the Video CD Play Mode” on page 34).

Supplementary explanation

“Chapters” are divisions of movies or musical selections on DVDs.

“Tracks” are divisions of movies or musical selections on Video CD, DVD Audio and music CDs.

“Groups” associate a track (one song) with other tracks stored on a DVD-Audio. Group playback differs, depending on the disc.

“Playlists” specify a range of images and their playback order.

- Only discs containing a playlist can be used.

Playing Still Frames (Pausing)

DVD-V DVD-A DVD-VR V CD

1 During playback, touch [▶/||].

2 Touch [▶/||] to resume playback.

- No sound is played during the still frame mode.
- The image or sound may stop temporarily when playback starts from the pause mode. This is not a malfunction.

Forward/reverse frame-by-frame Playback

DVD-V DVD-VR V CD

1 In the pause mode, touch [▶▶] or [◀◀].

The picture advances or reverses by one frame each time the button is touched.

2 Touch [▶/||] to return to normal mode.

- No sound is output during forward/reverse frame-by-frame playback.
- Reverse frame-by-frame cannot be carried out on the DVD-VR and Video CD.

Slow Motion Playback

DVD-V DVD-VR V CD

1 When [▶▶] or [◀◀] is touched and held while in the pause mode, the 1/8th speed slow motion playback mode is set.

When held in for 5 more seconds, the slow motion speed switches to 1/2 the normal speed.

2 Stop touching [▶▶▶] or [◀◀◀] to pause, and touch [▶/||] to play back.

- No sound is played during slow motion playback.
- Reverse slow motion playback is not available on the DVD-VR and Video CD.
- 1/2, 1/8 are approximate speeds. The actual speed differs from disc to disc.

Selecting Program (SKIP) (DVD-VR)

1 Touch [PAGE1/3] twice while playing a program of a DVD-VR disc.

The PROGRAM function guide is displayed.

2 Touch [▼] or [▲] of PROGRAM* to select the desired program.

* To switch [▼] or [▲] of PLAYLIST in the function guide display to [▼] or [▲] of PROGRAM, play back the program. For details, refer to "Searching by Program" (page 21).

Selecting Playlist (SKIP) (DVD-VR)

1 Touch [PAGE1/3] twice while playing a playlist of a DVD-VR disc.

The PLAYLIST function guide is displayed.

2 Touch [▼] or [▲] of PLAYLIST* to select the desired playlist.

* To switch [▼] or [▲] of PROGRAM in the function guide display to [▼] or [▲] of PLAYLIST, play back the playlist. For details, refer to "Searching by Playlist" (page 21).

Selecting Folders (DivX)

1 Touch [PAGE1/2].

The function guide appears.

2 Touch [▼ FLDR] or [FLDR ▲] to select the folder.

Repeat Playback

(DVD-V) (DVD-A) (DVD-VR) (V CD) (DivX)

Use this function to play the disc's titles, chapters or tracks, etc., repeatedly.

DVD Video

1 Touch [↺] on the main unit.

The repeat mode switches every time the button is touched.

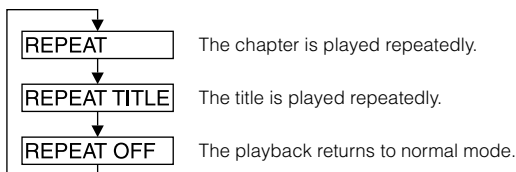

- Display may vary depending on the connected devices.
- The REPEAT mode is always turned off when [↺] is touched and held for at least 2 seconds.

Video CD

1 During playback, touch [↺] on the main unit.

The repeat mode switches every time the button is touched.

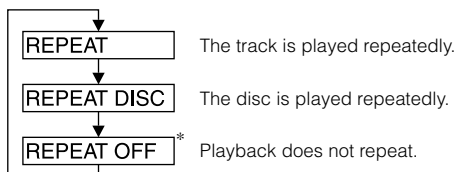

* Displayed only in the changer mode.

- Display may vary depending on the connected devices.
- The track/disc repeat modes cannot be used on Video CDs with playback control (PBC). These modes can be carried out after turning PBC off. See "Setting the Video CD Play Mode" on page 34.
- For some discs it is not possible to switch the repeat mode.

DVD Audio

1 Touch [↺] on the main unit.

The repeat mode switches every time the button is touched.

VCAP mode*1:

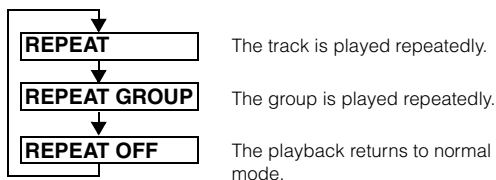

VOFF mode*1:

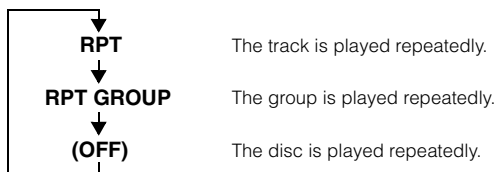

*1 When "VCAP" or "VOFF" is set in "Setting the DVD-Audio Playback Mode" (page 33).

DVD-VR

1 Touch [REPEAT] on the main unit.

The repeat mode switches every time the button is touched.

The Program mode*2:

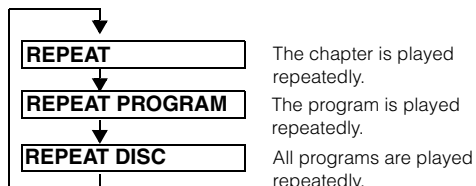

The Playlist mode*2:

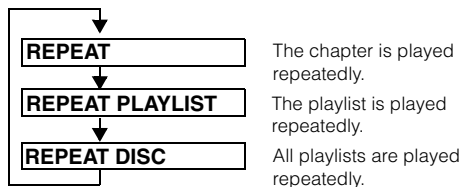

*2 To switch the Program mode display to the Playlist mode display on the DVD mode main screen, play back via program or playlist search. Refer to "Searching by Program" or "Searching by Playlist" (page 21).

- Only discs containing a Playlist can be displayed.

DivX®

1 Touch [REPEAT] on the main unit.

The repeat mode switches every time the button is touched.

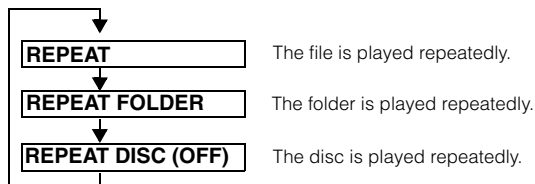

- The REPEAT mode is always turned off when [REPEAT] is touched and held for at least 2 seconds.

Searching by Title/Group/Program/Playlist/Folder Number

DVD-V DVD-A DVD-VR DivX

Use this function to easily find positions on the DVD using the DVD's titles, Groups, Programs or playlists.

1 Touch [PAGE1/2]* while playback is stopped.

The function guide appears.

* The display differs, depending on the disc (mode).

2 Touch [10KEY].

The numeric keypad input mode screen appears.

3 Enter a desired title, Group, Program or playlist by touching its title, Group, Program or playlist number.

See page 21 for operation of the numeric keypad.

4 Confirm your selection by touching [ENT].

Playback will start from the title number selected.

- To switch the Program mode display to the Playlist mode display on the DVD mode main screen, play back via program or playlist search. Refer to "Searching by Program" or "Searching by Playlist" (page 21).
- This function cannot be used on discs on which no title numbers are recorded.
- Playback starts from the beginning of the chapter/track number in the state of PRE STOP.
- Some disc may not accept any operation.

Searching Directly by Chapter, Track or File Number

DVD-V DVD-A DVD-VR V CD DivX

Use this function to easily move to the beginnings of the chapters, tracks or files on the disc.

1 Touch [PAGE1/2]* in any mode other than stop mode.

The function guide will appear.

* The display differs, depending on the disc (mode).

2 Touch [10KEY].

The numeric keypad input mode screen will appear.

3 Touch and enter the chapter or track number you want to play.

See page 21 for operation of the numeric keypad.

4 Touch [ENT] to confirm your selection.

Playback will start from the selected chapter or track.

- This function is not available for a disc on which chapters or tracks are not stored.
- Be sure to turn PBC off before starting the search (See "Setting the Video CD Play Mode" on page 34).

Switching the Angle DVD-V DVD-A

On DVDs in which scenes have been filmed from multiple angles, the angle can be switched during playback.

- 1 During playback, touch [PAGE1/2]*.**
The function guide changes.
* *The display differs, depending on the disc (mode).*

- 2 Touch [ANGLE].**
The angle switches between the angles recorded on the disc every time the button is touched.

- *Some time may be required for the angle to change.*
- *Depending on the disc, the angle may switch in one of two ways.*
 - *Seamless: The angle switches smoothly.*
 - *Non-seamless: When the angle is switched, a still picture is displayed first, after which the angle switches.*
- *To playback a DVD-Audio disc, set "VCAP" or "VIDEO" in "Setting the DVD-Audio Playback Mode" (page 33).*

Scroll to Move the Page Forward or Back

DVD-A

"Page" is a still image stored on a DVD-Audio disc.

- 1 Touch [PAGE1/3] twice while playing a DVD-Audio disc in VCAP mode*.**
* *Playing back a DVD-Audio disc when "VCAP" is set in "Setting the DVD-Audio Playback Mode" (page 33).*

- 2 Touch PAGE [▼] or [▲].**
The display switches.
Touch and hold to display the home page.

- *For DVD-Audio discs without Pages, depending on the DVD-Audio disc, the "Page" function may not be operable if images are in slide show form.*

Switching the Audio Tracks

DVD-V DVD-A DVD-VR V CD DivX

DVDs can have up to 8 different audio tracks. These alternate tracks can be switched during playback.

- 1 During playback, touch [PAGE1/2]*¹.**
*¹ *The display differs, depending on the disc (mode).*

- 2 Touch [AUDIO].**
The sound switches between the alternate audio tracks recorded on the disc every time the button is touched.

- *The alternate track selected becomes the default setting every time the power is turned on or the disc is replaced. If the disc does not include that track, the disc's default language is selected instead.*
- *Not all discs will allow changing the alternate audio tracks during playback. In these cases, select audio tracks from the DVDs menu.*
- *There may be a delay before the selected alternate track begins to play.*

Video CDs or DVD-VR with multiplex audio

- 1 During playback, touch [PAGE1/2]*².**
The function guide changes.
*² *Touch [PAGE1/3] while playing a DVD-VR disc.*

- 2 Touch [AUDIO]*³.**
The left and right channels will be output as shown below, each time the button is touched.
*³ *Touch [AUDIO] for at least 2 seconds to switch while playing a DVD-VR disc.*

AUDIO LR → AUDIO LL → AUDIO RR → AUDIO LR

Switching the Subtitles (Subtitle Language) DVD-V DVD-A DVD-VR DivX

With DVDs on which multiple subtitle languages are recorded, the subtitle language can be switched during playback; moreover, subtitles can be hidden.

- 1 During playback, touch [PAGE1/2]*.**
The function guide changes.
* *The display differs, depending on the disc (mode).*

- 2 Touch [SUBT.].**
Touching this button repeatedly selects sequentially the subtitle languages recorded on the disc, and then turns the subtitles OFF.

- *To play back a DVD-Audio disc, set "VCAP" in "Setting the DVD-Audio Playback Mode" (page 33).*
- *There may be a delay before the selected subtitle appears.*
- *Not all discs will allow changing the subtitles during playback. In these cases, select subtitles from the DVDs menu.*
- *The subtitle language selected becomes the default setting every time the power is turned on or the disc is replaced. If the disc does not include that language, the disc's default language is selected instead. However, the subtitle language may differ depending on the disc.*
- *For some discs, the subtitles will be displayed even when this is set to OFF. However, the subtitle language may differ depending on the disc.*
- *Switches the subtitles ON/OFF while playing a DVD-VR disc.*

Switching from the disc menu

DVD-V DVD-A

For some discs, the audio language, angle and subtitles can be switched from the disc menu.

- 1 Touch [MENU] or [TOP MENU] to display the menu.**

- 2 Select an item to confirm it.**
See "If a menu screen appears" on pages 20-21.

- *To play back a DVD-Audio disc, set "VCAP" in "Setting the DVD-Audio Playback Mode" (page 33).*

Displaying the Disc Status for DVD/Video CD

DVD-V DVD-A DVD-VR V CD DivX

Use the procedure described below to display the status (title number, chapter number, etc.) of the currently playing DVD or of the currently playing Video CD (track number, etc.) on the monitor.

1 During playback, touch the display panel.

The operation menu screen is displayed.

2 Touch [CONTROL] within 5 seconds.

The display status is displayed for 5 seconds.

- Touching an area other than the function guide in the display within 5 seconds, turns off the disc status display.
- To play back a DVD-Audio disc, set "VCAP" in "Setting the DVD-Audio Playback Mode" (page 33).

About DivX®

DivX® is a codec (software) program to compress moving images while maintaining image quality using a highly advanced compression ratio and operating speed.

- Official DivX® Certified product
- Plays all versions of DivX® video (including DivX® 5) with standard playback of DivX® media files
- DivX, DivX Certified, and associated logos are trademarks of DivX, Inc. and are used under license

The unit can play back CD-R/CD-RW/DVD-R/DVD-RW/DVD+R/DVD+RW discs that are recorded in the DivX® mode with extension "avi" or "divx".

The optimum size for DivX® disc playback is as follows:

Screen Size: 32 to 720 pixel (horizontal) × 32 to 576 pixel (vertical)

If an aspect ratio is set other than 720 pixel (horizontal) × 480 pixel (vertical), a black belt may be displayed on the left and right sides, or at the top and bottom of the screen.

Image bit rate: "average 4 Mbps, Peak 8 Mbps"
Home Theater Profile supported

The following audio recording systems are supported.

MPEG1 Layer II	64 to 384 kbps
MPEG1 Layer III	32 to 320 kbps
MPEG2 Layer III	8 to 160 kbps
MPEG2.5 Layer III	8 to 160 kbps
Dolby Digital	64 to 448 kbps (Max. 5.1ch)

Other Useful Features

Adjusting the Audio

1 Press SETUP.

The SETUP selection screen is displayed.

2 Touch [>>>] of AUDIO or press and hold the Rotary encoder for at least 2 seconds on the unit.

The display changes to the AUDIO setup screen.

Display Example for Audio setup Screen

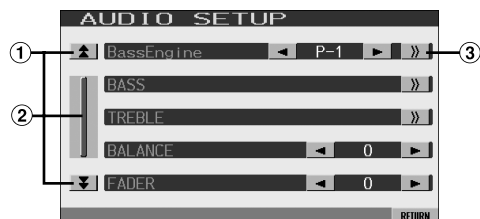

① Scrolls the page list up or down.

② Scrolls the list item by item.

Touching and holding will scroll continuously.

③ For details on how to use the BassEngine, refer to "BassEngine Operation" (page 43).

When an external audio processor is connected, the "BassEngine" indicator changes to "A.PROCESSOR." For A.PROCESSOR operation, refer to "External Audio Processor" (page 43).

- Touching [RETURN] will return to the previous display.
- When an external audio processor is connected, BASS, TREBLE or LOUDNESS is not displayed.

Adjusting Bass/Treble:

You can change the bass or treble frequency emphasis to create your own tonal preference.

Touch [>>>] to display the Bass or Treble adjusting screen.

Setting the Bass Center Frequency:

The displayed bass frequency is emphasized

Touch [◀] or [▶] of FREQ. to select the desired bass center frequency.

Setting range: 60Hz, 80Hz, 100Hz, 200Hz

Setting the Bass level:

You can emphasize or weaken the bass frequency.

Touch [◀] or [▶] of LEVEL to select the desired bass level.

Setting range: -7 to +7

Setting the Bass Bandwidth (Q-Factor):

Changes the boosted bass bandwidth to wide or narrow. A wide setting will boost a wide range of frequencies above and below the center frequency. A narrower setting will boost only frequencies near the center frequency.

Touch [◀] or [▶] of Q (BASS BANDWIDTH) to select the desired bass bandwidth.

Setting range: 1, 1.25, 1.5, 2

- The bass level settings will be individually memorized for each source (FM, AM, CD, etc.) until the setting is changed. The bass frequency and bass band width settings adjusted for one source are effective for all other sources (FM, AM, CD, etc.).

Setting the Treble Center Frequency:

The displayed Treble frequency is emphasized.

Touch [◀] or [▶] of FREQ. to select the desired treble center frequency.

Setting range: 10kHz, 12.5kHz, 15kHz, 17.5kHz

Setting the treble level:

You can emphasize the treble frequency.

Touch [◀] or [▶] of LEVEL to select the desired treble level.

Setting range: -7 to +7

- The treble level settings will be individually memorized for each source (FM, AM, CD, etc.) until the setting is changed. The Treble frequency settings adjusted for one source are effective for all other sources (FM, AM, CD, etc.).

Adjusting the Balance:

Touch [◀] or [▶] of BALANCE to adjust the sound volume of the left and right speakers.

Setting range: L15 to R15

Adjusting the Fader:

Touch [◀] or [▶] of FADER to adjust the volume of the front and rear speakers.

Setting range: F15 to R15

Setting the Loudness:

Loudness introduces a special low- and high-frequency emphasis at low listening levels. This compensates for the ear's decreased sensitivity to bass and treble sound.

Touch [◀] or [▶] of LOUDNESS to set to ON or OFF.

Adjusting the Subwoofer Level:

Touch [◀] or [▶] of SUBW. LV to adjust the subwoofer output.

Setting range: 0 to 15

- The level adjustment becomes available when ON is set in "Subwoofer On and Off" (page 38).

Adjusting NAV. LEVEL:

Touch [◀] or [▶] of NAV. MIX LV to adjust the volume of navigation interruption.

Setting range: 0 to 15

- This adjustment becomes available when NAV.MIX is turned on in "Setting the Navigation Interruption" (page 37).
- The setting navigation interruption is not displayed if an external audio processor not compatible with NAV.MIX is connected.

Turning Defeat ON or OFF:

Touch [◀] or [▶] of DEFEAT to set to ON or OFF.

If you set defeat to ON, adjusted bass/treble values return to their initial settings.

Search Function

- 1 Touch [🔍] on the function guide while in the CD or MP3/WMA/AAC or DivX® mode.

Search list screen is displayed.

Select a desired track or folder.

Touch [▶] for direct playback.

When a hierarchical list is prepared, [≫] will be displayed. Touch [≫] to display the respective hierarchy list screens.

Display Example for Search Screen

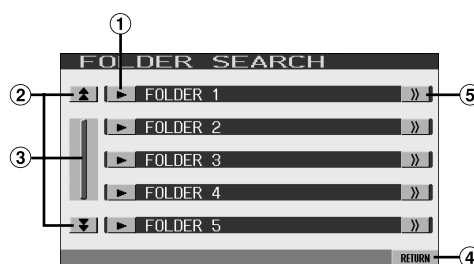

- ① Select directly by touching [▶], and its Track (or folder/file) is played back.
- ② Scrolls the page list up or down. (Displayed when the list items cannot be displayed entirely.)
- ③ Scrolls the list item by item. Touching and holding will scroll continuously. (Displayed when the list items cannot be displayed entirely.)
- ④ Touch [RETURN] to return to the previous list screen.
- ⑤ [≫] is displayed if there is a hierarchical list.

- The search function does not work on the DVD, Video CD or CD changer.
- A folder list is displayed only during MP3/WMA playback when the DVD player (DVA-5210) or changer compatible with MP3 is connected.

Internal CD player mode

- 1 The track list* screen appears.
* If the CD is text compatible only.
- 2 Touch [▶] of a desired track text*.
The selected track will be played back.
 - "TRACK" is displayed in the track text list if there is no text on the disc.

Internal MP3/WMA/AAC/DivX® Player/external MP3-compatible DVD Player/Changer Mode

- 1 The folder list screen appears.
Select a desired folder and then touch [>>].
([>>] appears only when a file is present in the selected folder.)
The file list screen is displayed.
 - Touch [▶] to play back the folder directly.
- 2 Touch [▶] of a desired file name.
The selected file will be played back.

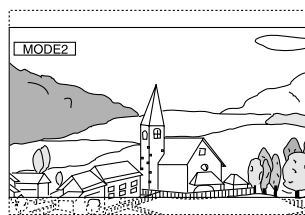

In Mode 2 (Cinema), the monitor displays a normal picture by stretching out the picture horizontally and vertically. This mode is good for displaying a cinema type picture at the 16 : 9 ratio.

Rear Selection Function

While listening to the radio or other audio source, at the same time, pictures in a disc inserted in the IVA-D105 can be enjoyed in the rear monitor. However, only pictures are output, not sound.

- 1 Press **SOURCE**/⏻.
The SOURCE selection screen is displayed.
- 2 Touch **[REAR]**.
Rear Select display appears.
 - This function cannot be used when “Setting the Picture/Sound Output” (page 38) is set to OFF in the SYSTEM SETUP.
 - If [MAIN] on the Rear Select screen is touched, the screen changes to the main source screen.
- 3 Touch the desired source such as visual (auxiliary input, built-in DVD, etc.) to select.
 - Touch [OFF] to cancel the rear entertainment function.
 - When the “Setting the AUX Mode” (page 37) is set to OFF, the auxiliary source is not displayed.

Switching Display Modes

After carrying out the steps 1 to 3 of “To display the DVD mode Screen” explained on page 29, perform the operation described below.

While your vehicle is parked, touch **[WIDE]** on the visual source screen or press **BAND** on the unit.

Each touch changes the display modes as follows:

MODE 1 → MODE 2 → MODE 3 → MODE 1
(WIDE) (CINEMA) (NORMAL) (WIDE)

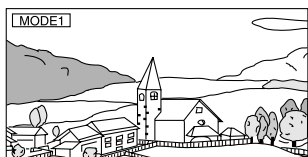

In Mode 1 (Wide), the monitor displays a normal picture wider to fit in a wide-screen monitor by evenly stretching out the picture horizontally.

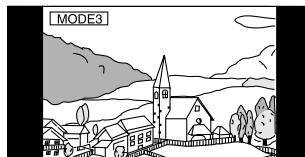

In Mode 3 (Normal), the monitor displays a normal picture at the center of the screen with a vertical black band at each side.

Switching the Visual Source Only (Simultaneous Function)

You can watch the video portion of another source while listening to the current source.

- After carrying out the steps 1 to 3 of “To display the DVD mode Screen” explained on page 29, perform the operation described below.

- 1 Press **VISUAL** on the unit.
The VISUAL selection screen appears.
- 2 Touch a desired visual source.
The visual source is switched to the selected one.

Cancelling the Simultaneous Function

- 1 Press **VISUAL**.
- 2 Touch **[NORMAL]**.
The simultaneous function is canceled.
 - To apply the setting, set to VISUAL in “Setting the VISUAL Button” (page 38).
 - If a DVD player is connected, you can receive the DVD picture. DVD changer (DHA-S680) is connected:
Press and hold **V.OUT** on the remote control supplied with the DVD player or DVD changer for more than 2 seconds. The picture of the DVD will be output.
The DVA-5210 is connected:
Press **V.OUT** on the remote control (included with the DVA-5210) to output DVD picture.
 - The simultaneous function cannot be used when the Audio source is in the navigation mode.
When NAV. is set in “Setting the VISUAL Button” (page 38), only the navigation screen can be recalled.
 - When the “Setting the AUX Mode” (page 37) is set to OFF, the auxiliary source is not displayed.

Blackout Mode On and Off

When Blackout mode is turned on, the monitor display will turn off to reduce power consumption.

This additional power enhances the sound quality.

- 1 Press VISUAL on the unit.**
The VISUAL selection screen is displayed.
- 2 Touch [OFF].**
The backlit-display portion goes out.
- 3 Touch [OFF] again to cancel the display backlight.**
 - To apply the setting, set to VISUAL in "Setting the VISUAL Button" (page 38).
 - If any button on the unit is pressed during Blackout mode, the function will be displayed for 5 seconds to show the operation before returning to Blackout mode.

Setting rear Camera Interruption

When the rear camera is connected, rear pictures are output on the screen.

- 1 Select CAMERA in "Setting the AUX Mode" (page 37).**
- 2 Press VISUAL on the unit.**
The VISUAL selection screen is displayed.
- 3 Touch [CAMERA].**
Rear picture is output even if you do not engage the shift lever in reverse (R).
- 4 To cancel the setting, press VISUAL on the unit, and touch [NORMAL].**
 - By shifting to reverse (R), the rear pictures are output. This function is effective when the reverse wire is properly connected.

Setup

DVD Setup

DVD Setup Operation

To display the DVD mode screen:

To watch a video source, your vehicle must be parked with the ignition key in the ACC or ON position. To do this, follow the procedure below.

- 1 Bring your vehicle to a complete stop at a safe location. Engage the parking brake.
- 2 Keep pushing the foot brake and release the parking brake once then engage it again.
- 3 When the parking brake is engaged for the second time, release the foot brake.

- For automatic transmission vehicles, place the transmission lever in the Park position.

Now, the locking system for the DVD mode operation has been released. Engaging the parking brake can reactivate the DVD mode, as long as the car's ignition has not been turned off. It is not necessary to repeat the above procedure (1 through 3), of "To display the DVD mode screen."

Each time the ignition is turned OFF, perform the procedure of "To display the DVD mode screen."

The DVD Setup operation can be carried out after removing the disc from the unit.

The following steps 1 to 5 are common operations to each "Setting item" of DVD Setup. Refer to each section for details.

- 1 Touch [SETUP] on the main source screen.**
The SETUP selection screen is displayed.
- 2 Touch [>>>] of SOURCE.**
The SOURCE SETUP screen appears.
- 3 Touch [>>>] of DVD.**
The DVD setup screen appears.
- 4 Touch [<<<] or [>>>], etc., of the desired item to change its setting.**

Setting items:

MENU LANGUAGE / AUDIO LANGUAGE / SUBT. LANGUAGE / COUNTRY CODE / PARENTAL / DIGITAL OUT / DOWNMIX MODE / TV SCREEN / BONUS CODE / DVD-A SETUP / DISC PLAY MODE / PLAY MODE / DivX Information / PBC

Display example for DVD setup screen

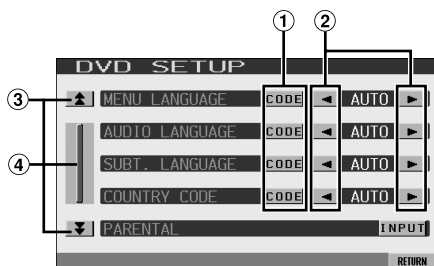

- ① Touch [CODE] to display the numeric keypad screen.
- ② Touch [◀] or [▶] to set a desired language.
- ③ Scrolls the page list up or down.
- ④ Scrolls the list item by item.
Touching and holding will scroll continuously.



- ① The numeric keypad input screen closes when the area is touched while displayed.
- ② Numeric keypad input screen
The numeric keypad is used if you want to play back in a language other than that displayed, or to input your parental lock password, etc.

5 Touch [RETURN] to return to the previous screen.

- Immediately after changing the settings of DVD mode (while the system is writing data automatically) do not turn the ignition key (engine key) to OFF. Otherwise, the settings may not be changed.

Changing the language setting

The audio language, subtitle language and menu language can be set according to your preferences.

Once set, this becomes the default language. This function is convenient when you always want to listen in English. (The language setting is not effective on some discs. If not, the default language is set from the factory.)

- When the settings are changed, the old settings are overwritten. Make a note of the current settings before making changes. The settings are cleared even when the vehicle's battery is disconnected.
- To temporarily change the language of the current disc, either do so from the DVD menu or by using the operation described in the section "Switching the Audio Tracks" (page 25).
- If the disc does not include the selected language, the disc's default language is set.

Setting of the Menu Language

Set the language used for the menus (title menu, etc.).

Setting item: MENU LANGUAGE

Setting contents: AUTO / EN / JP / DE / ES / FR / IT / SE / RU / CN

- When "AUTO" is selected, the primary menu language among the recorded ones is played.

Setting of the Audio Language

Set the audio language produced from the speakers.

Setting item: AUDIO LANGUAGE

Setting contents: AUTO / EN / JP / DE / ES / FR / IT / SE / RU / CN

- When "AUTO" is selected, the primary audio language among the recorded ones is played.

Setting of the Subtitle Language

Set the language of the subtitles displayed on the screen.

Setting item: SUBT. LANGUAGE

Setting contents: AUTO / EN / JP / DE / ES / FR / IT / SE / RU / CN

- When "AUTO" is selected, the primary subtitle language among the recorded ones is played.

To play in a language other than those displayed

- 1 Touch [CODE].
The numeric keypad screen is displayed.
- 2 Touch the 4-digit numeral of the language number.
As for the language number, refer to "List of Language Codes" (page 65).
- 3 Touch [ENT] to memorize the number.

Changing the Country Code Setting

Set the country number of which you want to set the rating level (Parental lock).

Setting item: COUNTRY CODE

Setting content: AUTO / OTHER

- AUTO:** The primary country code among the recorded ones is played.
- OTHER:** Touching [CODE] will display the currently selected country code in the input space.

- When the settings are changed, the old settings are overwritten. Make a note of the current settings before making changes. The settings are cleared even when the vehicle's battery is disconnected.

- 1 Touch [CODE] of COUNTRY CODE.
- 2 Touch [ALL DEL] or [BS].
Delete the displayed country number.
- 3 Touch the 4-digit country code.
As for the country number, refer to "List of Country Codes" (pages 66 and 67).
- 4 Touch [ENT] to memorize the code.

Setting the Rating Level (Parental Lock)

This function can help restrict the viewing of movies to children of appropriate age levels only.

Setting item: PARENTAL

Setting content: INPUT

- When the settings are changed, the old settings are overwritten. Make a note of the current settings before making changes. The memory is cleared when the vehicle's battery is disconnected.
- On unrated DVDs, playback will not be restricted even if the rating level is set.
- If you want to play back DVD software with the parental lock feature and its use is currently restricted, change the rating level and the country number in order to play back the DVD.
- Once set, this rating level remains in memory until changed. To enable playback of discs of higher rating levels or to cancel the parental lock, the setting must be changed.
- Not all DVDs provide a Parental Lock feature. If you are unsure about a DVD, play it first to confirm. Do not leave DVDs accessible to young children for whom you deem them inappropriate.
 - 1 Touch [INPUT].
The numeric keypad screen is displayed.
 - 2 Touch the numeric keypad to input a 4-digit password.
The initial number is 1111.
Input number are displayed as "*".
 - 3 Touch [ENT] to memorize the number.
The PARENTAL screen appears.

Set the rating level of PARENTAL

- 4 Touch [◀] or [▶] of PARENTAL to turn on.
- 5 Touch [◀] or [▶] of PARENTAL LEVEL to select the rating level (1 to 8).
Select "OFF" to cancel the parental lock or if you do not want to set a rating level. The smaller the number, the higher the rating level.
- 6 Touch [RETURN] to return to the previous screen.

Changing the password

- 4 Touch [INPUT] of PASSWORD CHANGE.
The numeric keypad screen is displayed.
- 5 Touch the input screen to enter a new 4-digit password.
 - Keep a note of the number somewhere safe in case you should forget it.
- 6 Touch [ENT] to memorize the number.
- 7 Touch [RETURN] to return to the previous screen.

Changing the rating level temporarily

Some discs may request that you change the rating level set in the default settings during playback. In this case, the message appears on the monitor screen "PARENTAL LEVEL CHANGE OK? [YES] [NO]."

If this screen appears, change the level as follows:

- **To change parental level and play, touch [YES].**
When [YES] is touched, the numeric keypad input screen is displayed. Input the 4-digit password in "Setting the Rating Level (Parental Lock)" you set, then touch [ENT].
- **To play without changing the parental level, touch [NO].**
(When [NO] is touched, playback will be at the parental level set in "Setting the Rating Level (Parental Lock).")

Changing the Digital Output Setting

Use the following procedure to set the digital audio signal output from the IVA-D105.

Setting item: DIGITAL OUT

Setting contents: BITSTREAM / PCM

- BITSTREAM:** The digital output is switched automatically according to the type of audio signals being played.
Be sure to select "BITSTREAM" when you want to connect a digital audio processor and play Dolby Digital audio. "BITSTREAM" is the factory setting.
- PCM:** The audio signals recorded on the disc are converted to 48 kHz/16 bit (for DVDs) or 44.1 kHz (for Video CDs and CDs) PCM audio signals for output.

Audio output/Optical digital audio output

Disc	Audio recording format		Digital output setting (DVD SETUP)	Optical digital audio output	Analog audio output (Ai-NET, RCA output)
	Format	Fs			
LPCM (CD-DA, DVD-V, DVD- A, DVD-VR)	44.1/176.4kHz	16/20/24bit	BITSTREAM or PCM	44.1kHz, 16bit, PCM 2ch (2ch Downmix)*	OK
	48/96/192kHz	16/20/24bit	BITSTREAM or PCM	48kHz, 16bit, PCM 2ch (2ch Downmix)*	OK
PPCM (DVD-A)	44.1/88.2/ 176.4kHz	16/20/24bit	BITSTREAM or PCM	Not output	OK
	48/96/192kHz	16/20/24bit			
Dolby Digital (-EX) (DVD-V, DVD- A, DVD-VR)	48kHz	16/18/20bit	PCM	48kHz, 16bit, Decoded 2ch (2chDownmix)*	OK
			BITSTREAM	Bit stream (Max 7.1ch)*	OK
DTS (-ES) (CD-DA, DVD-V, DVD- A)	44.1kHz	16/20/24bit	PCM	44.1kHz, 16bit Decoded 2ch (2chDownmix)*	OK
			BITSTREAM	Bit stream (Max 6.1ch)*	OK
	48/96kHz	16/20/24bit	PCM	48kHz, 16bit, Decoded 2ch (2chDownmix)*	OK
			BITSTREAM	Bit stream (Max 6.1ch)*	OK
MPEG1Layer II (VCD, DVD-V, DVD-A, DVD- VR)	44.1kHz	16bit	PCM	44.1kHz, 16bit, Decoded 2ch*	OK
			BITSTREAM	Bit stream*	OK
	48kHz	16bit	PCM	48kHz, 16bit, Decoded 2ch (2chDownmix)*	OK
			BITSTREAM	Bit stream (Max 5.1ch)*	OK
MPEG2Layer II (DVD-V, DVD- A, DVD-VR)	44.1kHz	16bit	PCM	44.1kHz, 16bit, Decoded 2ch*	OK
			BITSTREAM	Bit stream*	OK
	48kHz	16bit	PCM	48kHz, 16bit, Decoded 2ch (2chDownmix)*	OK
			BITSTREAM	Bit stream (Max 5.1ch)*	OK
MPEG1/2/ 2.5Layer III (MP3, WMA)	32kHz	16bit	BITSTREAM or PCM	32kHz, 16bit, Decoded 2ch	OK
	44.1kHz	16bit	BITSTREAM or PCM	44.1kHz, 16bit, Decoded 2ch	OK
	48kHz	16bit	BITSTREAM or PCM	48kHz, 16bit, Decoded 2ch	OK

* Not output when playing back a DVD-Audio.

Setting the Downmix Mode

This function applies to Dolby Digital, DTS stream sound.

Setting item: DOWNMIX MODE

Setting contents: SURROUND / STEREO

SURROUND: Surround compatible Downmix

STEREO: Stereo Downmix

Setting the TV Screen

Use the procedure described below to modify the output screen according to the type of TV monitor (rear monitor) being used. This setting can also be applied for the IVA-D105.

If the rear monitor is not connected, the screen setting is 16:9.

Setting item: TV SCREEN

Setting contents: 4:3 LB / 4:3 PS / 16:9

- For some discs, the picture may not be set to the selected screen size. (For details, refer to the explanation on the disc's jacket.)

4:3 LETTER BOX:

Select this when connected to a conventional 4:3 size (normal TV aspect ratio) monitor. There may be black stripes visible at the top and bottom of the screen (when playing a 16 : 9 size movie). The width of these stripes will depend upon the original aspect ratio of the theatrical release of the movie.



4:3 PAN-SCAN:

Select this when connected to a conventional 4:3 size monitor. The picture will fill the entire TV screen. However, due to the mismatch in aspect ratio, parts of the movie at the extreme left and right sides will not be visible (when playing a 16 : 9 size movie).



16:9 WIDE:

Select this when connected to a wide screen TV. This is the factory setting.



Setting of the Bonus Code (DVD-A)

Some DVD-Audio discs include bonus group.

The 4 digit code for the bonus group can be memorized.

Refer to the information on the jacket, etc., of the disc, for the code number.

Setting item: BONUS CODE

Setting contents: INPUT

1 Touch [INPUT].

The 10 key input screen is displayed.

2 Input the 4 digit code number given on the jacket of the disc, etc.

3 Touch [ENT] to memorize the number.

- If the code number of the bonus group differs from the code number you set in this section, the 10 key input screen automatically appears in the display. If a new code number is input, this code number will be replaced.

Setting the DVD-Audio Playback Mode

(DVD-A)

To playback the DVD Audio Disc, you have a choice of 3 different settings. If the disc containing DVD Video and Audio, set VCAP (Video Capable Audio Player) or VOFF (Video OFF) to playback the DVD Audio.

Setting item: DVD-A SETUP

Setting contents: VIDEO / VCAP / VOFF

VIDEO: Only DVD Video is played back if the disc contains DVD Video and Audio.

VCAP: DVD Audio is played back with Video.

VOFF: DVD Audio is played back without Video.

Setting the compressed File Playback Data

If a disc containing both a compressed video file and a compressed audio file is used, you have a choose to play back only a video or only audio.

Setting item: DISC PLAY MODE

Setting contents: VIDEO / AUDIO

- VIDEO: only VIDEO data is played back.
AUDIO: only AUDIO data is played back.

Playing MP3/WMA/AAC Data

When using discs containing both audio data and MP3/WMA/AAC data.

Setting item: PLAY MODE

Setting content: CD / CPM

- CD: Plays only the audio data on discs containing both audio data and MP3/WMA/AAC data.
CPM: Plays only the MP3/WMA/AAC files on discs containing both audio data and MP3/WMA/AAC data.
- If a disc is inserted, remove it from this unit before setting.
 - When an MP3-compatible CD changer is used, this setting cannot be applied.

Displaying DivX[®] Disc Information

Setting item: DivX Information

If [>>] of DivX Information is touched, a DivX[®] file registered code is displayed.

Setting the Video CD Play Mode

When playing a Playback Control (PBC) enabled Video CD, you can choose to set PBC ON or OFF.

Setting item: PBC

Setting contents: ON / OFF

- ON: The PBC menu is displayed.
OFF: The PBC menu is not displayed.

RADIO Setup

Digital SEEK Setting (HD Radio mode only)

After carrying out the steps 1 to 3 of “To display the General mode screen” explained on page 35, perform the operation described below.

1 Touch [SETUP] on the main source screen.
The SETUP selection screen is displayed.

2 Touch [>>] of SOURCE.
The SOURCE SETUP screen appears.

3 Touch [>>] of RADIO.
The RADIO setup screen appears.

4 Touch [◀] or [▶] of DIGITAL SEEK to toggle between ON and OFF.

- ON: SEEK UP/DOWN is used only for the digital radio station.
OFF: SEEK UP/DOWN is used for DIGITAL and ANALOG radio stations. However, the strong signals have priority during SEEK.

GENERAL Setup

General Setup Operation

To display the General mode screen:

To watch a video source, your vehicle must be parked with the ignition key in the ACC or ON position. To do this, follow the procedure below.

- 1 Bring your vehicle to a complete stop at a safe location. Engage the parking brake.
- 2 Keep pushing the foot brake and release the parking brake once then engage it again.
- 3 When the parking brake is engaged for the second time, release the foot brake.

- For automatic transmission vehicles, place the transmission lever in the Park position.

Now, the locking system for the General mode operation has been released. Engaging the parking brake can reactivate the General mode, as long as the car's ignition has not been turned off. It is not necessary to repeat the above procedure (1 through 3), of "To display the General mode screen." Each time the ignition is turned OFF, perform the procedure of "To display the General mode screen."

The following steps 1 to 4 are common operations to each "Setting item" of GENERAL Setup. Refer to each section for details.

- 1 Touch **[SETUP]** on the main source screen.
The SETUP selection screen is displayed.
- 2 Touch **[>>]** of **GENERAL SETUP**.
The GENERAL setup screen appears.
- 3 Touch **[<]** or **[>]**, etc., of the desired item to change its setting.

Setting items:

CLOCK / CLOCK ADJUST / DAYLIGHT SAVING TIME / DEMONSTRATION / BEEP / AUTO SCROLL / LANGUAGE SELECT / LED DIMMER LEVEL

- 4 Touch **[RETURN]** to return to the previous screen.

- Immediately after changing the settings of General Mode (While the system is writing data automatically) do not turn the ignition key (engine key) to OFF.
Otherwise, the settings may not be changed.

Displaying the Time

The clock indication on the monitor display is turned on or off respectively.

Setting item: **CLOCK**

Setting content: **OFF / ON**

Setting the Time

Setting item: **CLOCK ADJUST**

Further setting items : **HOURL / MINUTE / TIME ADJUST**

Setting content: **1-12 / 0-59 / RESET**

HOURL: Adjust the hour.

MINUTE: Adjust the minute.

RESET: If the clock shows less than 30 minutes past, the minute will be "0"; more than 30, the hour advances.

- The clock-adjusting mode is canceled when the power is turned off, when **[RETURN]** is touched.

Setting Daylight Saving Time

Setting item: **DAYLIGHT SAVING TIME**

Setting content: **OFF / ON**

ON: Place the Summer Time mode ON. The time advances by one hour.

OFF: Return to the ordinary time.

Demonstration Function

This unit is equipped with a demonstration function capable of showing basic operations of respective sources on the monitor display.

Setting item: **DEMONSTRATION**

Setting content: **OFF / ON**

ON: Turns on the demonstration mode to show the basic operations.

OFF: Turns off the demonstration mode.

- The demonstration operation is automatically repeated until the function is turned off.

Sound (Beep) Guide Function

Setting item: **BEEP**

Setting content: **OFF / ON**

ON: Activate the Sound Guide mode.

OFF: Deactivate the Sound Guide mode. The sound guide beep will not be produced when a button on the unit is pressed.

- A beep always sounds when opening or closing the monitor, regardless of this setting.

Setting the Scroll

This CD player can scroll the disc and track names recorded on CD-TEXT discs, as well as text information of MP3/WMA/AAC files, folder names, tags, HD Radio and SAT Radio.

Setting item: AUTO SCROLL

Setting content: OFF / ON

- ON: Turns on the AUTO scroll mode. Scroll display is repeated as long as the mode is turned on.
 - OFF: Turns off the AUTO scroll mode.
Scroll display is done once as a track is changed (only when the scroll display cannot appear entirely).
- The display scrolls on the unit when the screen is filled up.
 - Scroll display of the song, artist and album name is enabled when iPod is connected.

Changing the Russian Font

Two type of font can be selected.

Setting item: LANGUAGE SELECT

Setting content: MODE1 / MODE2

- MODE1: Usual font display (ISO8859-1)
- MODE2: Russian font display (WINDOWS-1251)

Adjusting the Dimmer of Button Lighting at Night

You can adjust the brightness of the button lighting at night with the dimmer.

Setting item: LED DIMMER LEVEL

Setting level: -2 to +2

- The adjustment is available when ON or AUTO is set in "Setting the Brightness of the Backlighting" (page 39).
- The adjusted brightness is reflected in the button lighting.

SYSTEM Setup

System Setup Operation

To display the System mode screen:

To watch a video source, your vehicle must be parked with the ignition key in the ACC or ON position. To do this, follow the procedure below.

- 1 Brake to bring your vehicle to a complete stop at a safe location. Engage the parking brake.
- 2 Keep pushing the foot brake and release the parking brake once then engage it again.
- 3 When the parking brake is engaged for the second time, release the foot brake.

- For automatic transmission vehicles, place the transmission lever in the Park position.

Now, the locking system for the System mode operation has been released. Engaging the parking brake can reactivate the System mode, as long as the car's ignition has not been turned off. It is not necessary to repeat the above procedure (1 through 3), of "To display the System mode screen."

Each time the ignition is turned OFF, perform the procedure of "To display the System mode screen."

The following steps 1 to 5 are common operations to each "Setting item" of SYSTEM Setup. Refer to each section for details.

- 1 Touch [SETUP] on the main source screen.**
The SETUP selection screen is displayed.
- 2 Touch [>>>] of SYSTEM SETUP.**
The SYSTEM setup screen appears.
- 3 Touch [◀] or [▶] of the desired item to change its setting.**

Setting items:

IN INT. MUTE / IN INT. ICON / REMOTE SENSOR*¹ / NAV. IN / NAV. MIX*² / AUX IN / AUX IN LEVEL*³ / USB ADAPTER / CAMERA IN / AUX OUT / Bluetooth IN / VISUAL KEY / SUBW. OUT*⁴ / OPTICAL OUT

*¹ When ON is set in "Setting the Picture/Sound Output" (page 38), the item is displayed.

*² When ON is set in "Setting the Navigation Mode" (page 37), the item is displayed.

*³ When ON is set in "Setting the AUX Mode" (page 37), these items are displayed.

*⁴ Not displayed when an external audio processor is connected.

- 4 Touch [RETURN] to return to the previous screen.**
 - Immediately after changing the settings of System Mode (While the system is writing data automatically) do not turn the ignition key (engine key) to OFF.
Otherwise, the settings may not be changed.

Setting the External Device Interrupt Mode

If an Alpine Ai-NET Auxiliary Input Adapter (KCA-801B) is connected to the IVA-D105, an Auxiliary Source will be allowed to interrupt the current audio source. For example, you can listen to a portable MP3 player through your car audio system even with a CD changer connected and playing. The CD changer will automatically mute when switched to the AUX Input. For further details on how to use the Alpine KCA-801B, see your authorized Alpine dealer.

Setting item: IN INT. MUTE

Setting content: OFF / ON

- OFF: The volume level can be adjusted in Interrupt mode.
- ON: Sound will not be output.

- *The auxiliary device being connected must have an Interrupt wire with a negative trigger for this function to operate automatically. Otherwise, a separate switch needs to be added to switch it manually.*

Setting the Interrupt Icon Display

The unit can display the icon of an external device, such as a telephone, whenever a phone call comes in to tell you there is a phone call.

Setting item: IN INT. ICON

Setting content: INT / TEL

- INT: The INT icon appears on the display.
- TEL: When the external device (telephone) sends the interrupt signal, the telephone icon appears on the display.

Switching the function of the remote sensor

For remote control operation, the remote sensor of the external device (monitor, etc.) can be switched, as you prefer.

Setting item: REMOTE SENSOR

Setting contents: FRONT / REAR

- FRONT: The remote sensor of this unit is effective.
- REAR: The remote sensor of the external monitor connected to AUX OUT of this unit becomes effective. The remote control operates the source connected to the AUX OUT terminals.

- *The touch panel rear monitor sensor has priority over the remote control sensor. If the rear monitor (connected to the Alpine rear monitor output via the Monitor control lead) is touched, the command is executed regardless of the remote control sensor switch setting. Note, however, that the remote control sensor that has been set takes priority if it has been 5 seconds since last touching the panel.*
- *When an optional DVD changer or DVD player is connected, and the remote control sensor is set to REAR, some soft button operations ([■] STOP, etc.) cannot be performed. In this case, set the remote control sensor to FRONT.*

Setting the Navigation Mode

When you connect an optional navigation equipment, set it to ON.

Setting item: NAV. IN

Setting contents: OFF / ON

- ON: Navigation source is displayed.
- OFF: Navigation source is not displayed. The settings related to the navigation can not be changed from this unit.

Setting the Navigation Interruption

With an Alpine navigation system connected to the IVA-D105, the voice guidance of the navigation system will be mixed with the radio or CD play.

Setting item: NAV. MIX

Setting content: OFF / ON

- OFF: The navigation interruption mode is turned off.
- ON: The navigation interruption mode is on.

See "Adjusting NAV. LEVEL:" under "Adjusting the Audio" on page 27 to set the navigation interruption volume level.

- *The volume level for voice prompts during navigation guidance is set by adjusting the its volume while the prompts are announced. When the announcement finishes, the normal audio volume and the previous audio screen are restored. The voice prompt volume is always at or below the current listening volume. If a navigation announcement cuts in while adjusting the audio level, it always resets to the current level regardless of the audio level setting.*
- *This setting is effective when NAV.IN of SYSTEM list screen is ON.*

Setting the AUX Mode

Setting item: AUX IN

Setting content: OFF / ON / VCR / GAME / TV / EXT. DVD / EXTPLYR

- OFF: AUX source is not displayed.
- ON: AUX source is displayed.

- *OFF is not displayed when the optional DVD player or DVD changer is connected. During SYSTEM set up, although the AUX name can be changed, it is not displayed on the SOURCE selection screen.*
- *When OFF is selected, the settings related to AUX cannot be changed from this unit.*
- *The selected name is displayed on the VISUAL and REAR selection screen.*
- *Only when an Alpine TV tuner is connected, you can operate the displayed function guide from this unit.*
- *The selected source name is displayed instead of AUX source name. Select SOURCE to switch to the guide function of each mode.*

Adjusting the External Input Audio Level

After setting to ON in “Setting the AUX Mode,” this setting can be carried out.

Setting item: AUX IN LEVEL

Setting content: LOW / HIGH

LOW: Decreases the external input audio level

HIGH: Increases the external input audio level

Setting the USB Adapter to ON/OFF

If a USB Adapter is to be used, set to ON.

Setting item: USB ADAPTER

Setting content: OFF / ON

OFF: Does not display the USB source name on the SOURCE select screen.

ON: Displays the USB source name on the SOURCE select screen.

- If ON is set even when a CD changer is connected, the source name on the SOURCE select screen will change from CD CHG to USB.

Setting the Rear Camera Input

With a rear camera connected, rear view video is output to the monitor.

Setting item: CAMERA IN

Setting contents: OFF / ON

OFF: The CAMERA source is not displayed on the VISUAL selection screen.

ON: Even if the shift lever is not set to reverse (R), the rear pictures are output by selecting the CAMERA source.

- By shifting to reverse (R), the rear pictures are output. This function is effective when the reverse wire is properly connected.
- To apply the setting, set to VISUAL “Setting the VISUAL Button” (page 38).

Setting the Picture/Sound Output

Outputs the picture/sound of the source selected on the IVA-D105 connected to the rear monitor.

Setting item: AUX OUT

Setting content: OFF / ON

ON: The “REAR SELECT” item is displayed on the SETUP select screen. Touch [>>>] of REAR SELECT to change to the REAR select screen, then touch [▶] of the desired source. The selected source picture/sound is output on the rear monitor.

OFF: The “REAR SELECT” item is not displayed on the SETUP select screen.

Setting the Bluetooth Connection (Bluetooth IN)

Setting item: Bluetooth IN

Setting contents: NAV. / ADAPTER / OFF

NAV.: select when an optional Portable Navigation is connected.

Change voice line to RCA when TEL rings.

ADAPTER: select when an optional Bluetooth box is connected.

When external interruption occurs, the display changes to the TEL screen.

A source name of TEL on the SOURCE selection screen is displayed.

OFF: Select to ignore any external interrupts.

- For details on Bluetooth operation, refer to the Owner’s Manual of the Bluetooth Box.

Setting the VISUAL Button

Setting item: VISUAL KEY

Setting content: VISUAL / NAV.

NAV.: Switches directly to the navigation screen by pressing VISUAL. (Only when an Alpine optional RGB Navigation is connected.)

VISUAL: Recalls the VISUAL Select screen by pressing VISUAL.

Subwoofer On and Off

Setting item: SUBW. OUT

Setting contents: ON / OFF

ON: Subwoofer output is on.

OFF: Subwoofer output is off.

Setting the Digital Output

To connect an audio processor using the optical digital output, set to “ON” by the following procedure.

Setting item: OPTICAL OUT

Setting contents: OFF / ON

- Afterwards, set ACC to OFF once, then turn it ON again. The setting of Digital Output is decided.

DISPLAY Setup

Display Setup Operation

To display the Display mode screen:

To watch a video source, your vehicle must be parked with the ignition key in the ACC or ON position. To do this, follow the procedure below.

- 1 Bring your vehicle to a complete stop at a safe location. Engage the parking brake.
- 2 Keep pushing the foot brake and release the parking brake once then engage it again.
- 3 When the parking brake is engaged for the second time, release the foot brake.

- For automatic transmission vehicles, place the transmission lever in the Park position.

Now, the locking system for the Display mode operation has been released. Engaging the parking brake can reactivate the Display mode, as long as the car's ignition has not been turned off. It is not necessary to repeat the above procedure (1 through 3), of "To display the Display mode screen."
Each time the ignition is turned OFF, perform the procedure of "To display the Display mode screen."

The following steps 1 to 4 are common operations to each "Setting item" of DISPLAY Setup. Refer to each section for details.

- 1 Touch **[SETUP]** on the main source screen.
The SETUP selection screen is displayed.
- 2 Touch **[>>]** of **DISPLAY SETUP**.
The DISPLAY setup screen appears.
- 3 Touch **[<]** or **[>]** etc., of the desired item to change its setting.

Setting items:

TILT* / OPEN/CLOSE* / VISUAL EQ / DIMMER / DIMMER LOW LEVEL / AUTO BACKGROUND / BACKGROUND / DATA DOWNLOAD / BASE COLOR / PULSETOUCH / SCREEN ALIGNMENT

* These functions are adjustable while driving.

- 4 Touch **[RETURN]** to return to the previous screen.

- Immediately after changing the settings of Display Mode (While the system is writing data automatically) do not turn the ignition key (engine key) to OFF.
Otherwise, the settings may not be changed.

Adjusting the Monitor Angle

Adjust the monitor's angle (between 40 and 105 degrees) for optimum visibility.

Setting item: TILT

Setting range: 10 adjustable angles are available.

- If the monitor touches an obstacle, remove the obstacle.
- The screen color will vary when viewed at certain angles. Adjust the screen angle for the best viewing position.
- If the voltage of the vehicle's battery power is low, the screen may blink when the screen angle is changed. This is not a malfunction.

Setting Automatic Opening/Closing of the Monitor

Setting item: OPEN / CLOSE

Setting content: MANUAL / FULL / CLOSE

MANUAL: The monitor is manually opened or closed by pressing OPEN.

FULL: The monitor automatically opens and closes when the ignition key is turned to the "ACC" or "ON/OFF" position.

CLOSE: The monitor automatically closes when the ignition key is turned OFF.

Setting the Brightness of the Backlighting

Backlighting is provided by a fluorescent light built into the liquid crystal panel. The illumination control adjusts the brightness of the backlighting based on the car ambient lighting for easier viewing.

Setting item: DIMMER

Setting content: OFF / ON / AUTO

OFF: Deactivate Auto Dimmer mode to keep the background illumination of the monitor bright.

ON: Keep the background illumination of the monitor dark.

AUTO: Adjust the brightness of the background illumination of the monitor automatically to the brightness of the car interior.

- When ON or AUTO is set, the setting is also applied for the button lighting in "Adjusting the Dimmer of Button Lighting at Night" (page 36).

Adjusting the Minimum Level of Backlight

You can adjust the brightness of the backlight (LOW). This function could be used, for instance, to change the screen brightness while travelling at night.

Setting item: DIMMER LOW LEVEL

Setting content: -15 to +15

You can adjust the level between -15 and +15.

Switching Background Textures

You have a choice of background textures you can set.

Setting item: BACKGROUND

Setting content: MODE1 / MODE2

- This operation can be carried out after removing the disc from the unit or when playback of the disc has stopped.
- Wallpapers downloaded from "Downloading the BACKGROUND data" (page 42) are recalled.
- When you select a source other than the built-in disc on this unit, and the built-in disc is selected on the rear monitor connected to the unit, background textures cannot be displayed on the unit.
- When an error message is displayed (ERROR, HI-TEMP, etc.), background textures selected by this setting cannot be displayed on the unit.

Setting Automatic Background Textures

The background texture will automatically change each time the ignition key is turned off and turned back on again.

Setting item: AUTO BACKGROUND

Setting content: OFF / ON

ON: Turn on the Auto Background Texture Scroll mode.
The background textures will scroll when the ignition key is turned off once and turned back on again as follows:

MODE1 ↔ MODE2

OFF: Turn off the Auto Background Texture Scroll mode.

- Wallpapers downloaded from "Downloading the BACKGROUND data" (page 42) are recalled.

Switching the Font Background Color

You can choose from 5 different colors for the font background.

Setting item: BASE COLOR

Setting contents: MODE 1 to MODE 5

Turning the Touch Panel Vibration ON or OFF

You can turn the touch panel's vibration ON or OFF during operation.

Setting item: PULSETOUCH

Setting content: OFF / ON

OFF: Turns off vibration during operation.



ON: Turns on vibration during operation.

Adjusting the Touch Panel

Adjustment becomes necessary when the display position on the LCD and the touch position on the touch panel do not match.

Setting item: SCREEN ALIGNMENT

Setting content:  / RESET

- 1 Touch [] of SCREEN ALIGNMENT.
The adjustment screen appears.
- 2 Accurately touch the  mark provided in the lower left corner of the screen.
The screen changes to the adjustment screen.
- 3 Accurately touch the  mark provided in the upper right corner of the screen.
This completes adjustment, and returns to the DISPLAY setup mode screen.

- If you have touched a location other than the  mark, touch [RESET] to restore the adjustment screen to the initial setting.
- If you touch [RETURN] on the adjustment screen, no adjustment is done and the DISPLAY setup screen is restored.

VISUAL EQ™

Visual EQ Setting Operation

The following steps 1 to 4 are common operations to each "Setting item" of VISUAL EQ setting. Refer to each section for details

- 1** After steps 1 and 2 in "Display Setup Operation" (page 39) have been performed, touch [>>>] of VISUAL EQ.
VISUAL EQ screen appears.
- 2** Select a desired setting item by touching [▲] or [▼].
Setting items:
VISUAL EQ* ↔ BRIGHT ↔ COLOR* ↔ TINT* ↔ CONTRAST
↔ SHARP* ↔ USER PRESET*
* The setting is available in the visual source mode. (except navigation screen)
- 3** Change the setting on the selected item by touching its [◀] or [▶].
- 4** Touch [RETURN] to return to the previous screen.

Selecting the VISUAL EQ Mode (Maker's setting)

You can select a mode suitable for the subject image.

Setting item: VISUAL EQ

Setting contents: OFF (FLAT) / NIGHT M. / SOFT / SHARP / CONTRAST / P-1 / P-2

OFF (FLAT):	Initial Setting
NIGHT M.:	Suitable for movies in which dark scenes frequently appear.
SOFT:	Suitable for CGs and animated films.
SHARP:	Suitable for old movies where images are not clearly shown.
CONTRAST:	Suitable for recent movies.
P-1:	Recalls the VISUAL EQ mode being stored on preset No.P-1 from "Storing VISUAL EQ" (page 42).
P-2:	Recalls the VISUAL EQ mode being saved on preset No.P-2 from "Storing VISUAL EQ" (page 42).

- To return to the initial setting after selecting any one of the setting contents (NIGHT M. to CONTRAST) and adjusting a desired brightness, picture tint, etc., set this function to OFF.
- If your desired brightness, picture tint, etc., are adjusted after selecting any one of the setting contents (NIGHT M. to CONTRAST), "CUSTOM" is displayed.

Adjusting Brightness

Setting item: BRIGHT

Setting content: -15 ~ +15

You can adjust the brightness between MIN (-15) and MAX (+15). When it reaches the minimum or maximum point, the display shows "MIN" or "MAX" respectively.

- When any Visual EQ Preset is selected, the brightness is automatically adjusted according to the car's interior lighting as long as AUTO is set in "Setting the Brightness of the Backlighting" (page 39).

Adjusting Color of Picture

Setting item: COLOR

Setting content: -15 ~ +15

You can adjust the color between MIN (-15) and MAX (+15). When it reaches the minimum or maximum point, the display shows "MIN" or "MAX" respectively.

- Color adjustment can be made only in the navigation, DVD, Video CD, AUX modes.
- Color adjustment cannot be made if a Navigation system with the RGB feature is connected.

Adjusting Tint of Picture

Setting item: TINT

Setting content: G15 ~ R15

Adjust the color from G15 to R15. "G MAX" or "R MAX" is displayed at the maximum of each color.

- Tint adjustment can be made only in the navigation, DVD, Video CD, AUX modes.
- Tint adjustment cannot be made if a Navigation system with the RGB feature is connected.
- When the picture from the external input is set to PAL, you cannot adjust the TINT.

Adjusting Image Contrast

Setting item: CONTRAST

Setting content: -15 to +15

Adjustment of contrast is done in the range of -15 to +15. "HIGH" and "LOW" appear as the maximum and minimum values specified.

- When any NIGHT M. to CONTRAST setting item is selected, image contrast is automatically adjusted according to the car's interior brightness if AUTO is set in "Setting the Brightness of the Backlighting" (page 39).

Adjusting Picture Quality

Setting item: SHARP

Setting content: -15 to +15

Adjustment of picture quality is done in the range of -15 to +15.

- *Picture quality adjustment can be made only in the navigation, DVD, Video CD, AUX modes.*
- *Picture quality adjustment cannot be made if a navigation system with the RGB feature is connected.*

Storing VISUAL EQ

You can store the settings made for “Adjusting Image Brightness, Tint, Depth, picture Quality and Contrast.”

Setting item: USER PRESET

Setting content: P-1 / P-2

- 1 After completing “Adjusting Brightness, Tint, Depth, Picture Quality, and Contrast” (pages 41 and 42), touch [◀] or [▶] of USER PRESET and then select preset No. “P-1” or “P-2” to which the settings are to be stored.
 - 2 After selecting a preset No., touch [MEMORY].
The adjusted VISUAL EQ mode is stored by the above operations.
- *You can recall the VISUAL EQ mode stored here from P-1 or P-2 of “Selecting the VISUAL EQ Mode (Maker’s setting)” (page 41).*

Data Download

Downloading the BACKGROUND data

You can download data (from Alpine’s website) to a CD-R/CD-RW (data is written in the root folder), and store the data to the IVA-D105. To start BACKGROUND download, access the URL below and follow the on-screen instructions.

<http://www.alpine.com> or <http://www.alpine-europe.com>
or <http://www.alpine.com.au>

- 1 **Insert the CD-R/CD-RW disc containing the data you need.**
Data search of the disc starts. After completing the data search, the file selection screen of Data Download is displayed.
- 2 **After steps 1 and 2 in “Display Setup Operation” (page 39) have been performed, touch [≫] of DATA DOWNLOAD.**
- 3 **Touch [◀] or [▶], then select P-1 or P-2.**
The selected wallpaper can be changed.
- 4 **Touch [▲] or [▼] to select the desired file name.**
- 5 **Touch [MEMORY].**
Data download starts.
When data downloading has completed correctly, the screen returns to the DATA DOWNLOAD screen.
- 6 **Touching [RETURN] returns to the previous screen.**
 - *For details about procedures of download, see ALPINE’s Web site.*
 - *If data is newly downloaded, the data overwrites the previous data.*
 - *If the battery power cable is removed, the downloaded data is memorized.*
 - *You can recall a wallpaper in “Switching Background Textures” (page 40), or “Setting Automatic Background Textures” (page 40).*
 - *When download has completed, remove the disc.*

Adjusting Sound

The unit includes a function to create better sound in a car environment. The BassEngine menu lets you select standard adjustments as well as 5.1 surround sound settings. If the unit is connected to an optional external processor, the adjustment will be made by A.PROCESSOR. Adjustment can only be made after you have brought your vehicle to a complete stop in a safe location.

To display the BassEngine or Audio processor mode screen:

To watch a video source, your vehicle must be parked with the ignition key in the ACC or ON position. To do this, follow the procedure below.

- 1 Bring your vehicle to a complete stop at a safe location. Engage the parking brake.
- 2 Keep pushing the foot brake and release the parking brake once then engage it again.
- 3 When the parking brake is engaged for the second time, release the foot brake.

- For automatic transmission vehicles, place the transmission lever in the Park position.

Now, the locking system for the BassEngine or Audio processor mode operation has been released. Engaging the parking brake can reactivate the BassEngine or Audio processor mode, as long as the car's ignition has not been turned off. It is not necessary to repeat the above procedure (1 through 3), of "To display the BassEngine or Audio processor mode screen."

Each time the ignition is turned OFF, perform the procedure of "To display the BassEngine or Audio processor mode screen."

BassEngine Operation

BassEngine Operation

BassEngine : the following settings can be made for standard BassEngine on the unit.

- The settings can be made by the BassEngine only when in multi-channel playback. However, the front/rear HPF setting for the X-OVER adjustment can be made even when not in multi-channel playback.

Following Steps 1 to 5 describe the common procedures for operating the BassEngine setting function. For details of the setting function items, refer to descriptions of respective items.

- 1 **Check the Defeat mode is off (page 27), and then touch [SETUP] on the main source screen.**
The SETUP selection screen is displayed.
- 2 **Touch [>>] of AUDIO.**
The AUDIO setup screen appears.
- 3 **Touch [>>] of BassEngine.**
The BassEngine list screen appears.
- 4 **Touch [>>] etc., of the desired item to change its setting.**

Setting items :

X-OVER / T.CORR / DOLBY PLII / REAR FILL /
SPEAKER SELECT / MULT CH SETUP / SPEAKER SETUP /
BASS SOUND CONT. / USER PRESET

- 5 **Touch [RETURN] to return to the previous screen.**

External Audio Processor Operation

External Audio Processor (Optional)

When an external audio processor is connected to this unit, you can operate it from this unit. Some audio processors may not be operated. In this case, operate them in the connected product. Explanations below is the case when PXA-H700 or PXA-H701 is connected for example. Refer also to the operating instructions of the connected audio processor.

- The adjustments or settings performed on the connected audio processor cannot be operated properly from this unit.
- The setting "Setting the Speakers", "Setting Bass Sound Control", and "Graphic Equalizer Adjustments" are not available if the MRA-D550 is connected. Additionally, if the MRA-F350 is connected, the following setting "Setting the MX mode" is not available. Also, the setting content differs between the PXA-H700 and PXA-H701.
- This unit cannot be connected to the PXA-H510 and PXA-H900.

Adjustment Procedure for Dolby Surround

Make the adjustments described below in order to reproduce Dolby Digital and DTS sound with greater accuracy.

Adjustment procedure

- 1 **Speaker Setup (page 48)**
(Turning the speakers to be used on and off and setting their response)
- 2 **Adjusting the speaker levels (page 49)**
(Adjusting the signal output level to the various speakers)
- 3 **Mixing bass sound to the rear channel (page 49)**
(Achieving smooth sound in the rear seat by mixing the front audio signals with the rear speaker signals)
- 4 **Adjusting the acoustic image (page 49)**
(Adjusting the acoustic image to achieve a sound as if the centre speaker were directly in front of the listener)
- 5 **Achieving powerful high volume sound (page 49)**
(Achieving energetic sound with even greater power, like the sound in a movie theater)
- 6 **Adjusting the DVD Level (page 50)**
(Adjust the volume (signal level) in the Dolby Digital, Pro Logic II, DTS and PCM modes.)
- 7 **Storing Settings in the Memory (page 50)**
(Storing all the settings and adjustments made on the IVA-D105 (not only the above settings/adjusts) in the memory)

In case of combining the Automatic adjustments, etc.
We recommend to make the Automatic adjustments before the Dolby Surround adjustments.

A.PROC: the following settings can be made for an external audio processor.

Following Steps 1 to 5 describe the common procedures for operating the Audio Processor setting function. For details of the setting function items, refer to descriptions of respective items.

- 1 **Check the Defeat mode is off (page 27), and then touch [SETUP] on the main source screen.**
The SETUP selection screen is displayed.
 - 2 **Touch [>>>] of AUDIO.**
The AUDIO setup screen appears.
 - 3 **Touch [>>>] of A.PROCESSOR.**
The A.PROCESSOR list screen appears.
 - 4 **Touch [◀][▶] or [>>>] of the desired item to change its setting.**
- Setting items :**
X-OVER / T.CORR / PHASE / G-EQ / P-EQ / MEDIA XPANDER / BASS SOUND CONT. / DOLBY PLII / REAR FILL / SPEAKER SELECT / MULTI CH SETUP / SPEAKER SETUP / DVD LEVEL / PCM MODE / USER PRESET
- 5 **Touch [RETURN] to return to the previous screen.**

Setting the Speakers **BassEngine** **A.PROC**

Setting item : SPEAKER SELECT

Set the connected speaker by touching the respective [◀] or [▶] button.

BassEngine

FRONT:	ON Fixed
REAR:	OFF/ON
CENTER:	OFF/ON
SUBW.:	OFF/ON

A.PROCESSOR

FRONT1:	OFF/FULL (Full Range)/TW (Tweeter)
FRONT2:	OFF/ON
REAR:	OFF/ON
CENTER:	OFF/ON
SUBW.:	OFF/MONO/STEREO

- Set the speaker which is not connected to OFF.
- Settings above can be carried out even when the speaker is set to OFF in "Speaker Setup" (page 48).
- To use the subwoofer in MONO with PXA-H700 or PXA-H701 connected, connect the subwoofer to the subwoofer output terminal of PXA-H700 or PXA-H701.

Set MX Mode of the External Audio Processor (A.PROC)

Before performing the operations below, set MX (Media Xpander) mode of the PXA-H700 to "AUTO" when the PXA-H700 is connected.

Setting item : MEDIA XPANDER

1 Select ON or OFF of MX by touching [◀] or [▶] of MEDIA XPANDER.

OFF: Turns off the MX effect of every music source.
ON: Turns on the specified MX mode.

2 Touch [≫] after setting to ON.

The Media Xpander setup screen appears.

3 Touch [◀] or [▶] of the desired MX mode.

- Music source (such as radio broadcasts and CDs, excluding AM radio) level can be set.

MX CD (OFF, CD MX 1 to 3)

CD mode processes a large quantity of data. This data is used to reproduce the sound cleanly by making use of the data quantity.

MX CMPM (OFF, CMPM MX 1 to 3) / MX SAT (OFF, SAT MX 1 to 3)

This corrects information that was omitted at the time of compression. This reproduces a well-balanced sound close to the original.

MX FM (OFF, FM MX 1 to 3)

The medium to high frequencies become more clear, and produces well balanced sound in all the bands.

MX DVD (OFF, MOVIE MX 1 to 2)

The dialog portion of the video is reproduced more clearly.

(DVD MUSIC)

This disk contains a large quantity of data such as music clip. MX uses this data to reproduce the sound accurately.

MX AUX (OFF, CMPM MX, MOVIE MX, MUSIC MX)

Choose the MX mode (CMPM, MUSIC, or MOVIE) that corresponds to the media connected.

- The contents of MX set here is reflected to PXA-H700 or PXA-H701.
- When OFF is selected, MX effect of each MX mode will be OFF.
- Each music source, such as radio, CD, and MP3 can have its own MX setting.
- MX mode does not function when MX is ON for AM radio.
- MX CMPM is applied for MP3/WMA/AAC and iPod.
- MX SAT is applied for XM, SIRIUS, HD Radio.
- The MX setting can be performed only when a source is currently selected.

X-OVER Adjustment (BassEngine) (A.PROC)

Setting item : X-OVER

BassEngine

High pass filter can be applied to front/rear speakers, and low pass filter can be applied to the subwoofer.

1 Touch [◀] or [▶] of the speaker to make the desired adjustment.

- If you set the subwoofer LPF, set the front/rear HPF to OFF, or set the rear/front speaker to "LARGE" in "Speaker Setup" (page 48). The frequency you set for the subwoofer LPF will automatically be applied for the speaker that is set to "SMALL" for the HPF. Therefore, certain frequencies may not be reproduced.

A.PROCESSOR

1 Touch [◀] or [▶] of X-OVER to select L/R or L+R.

L/R: Different adjustment values can be set for the left and right channels.

L+R: Sets the same adjustment values for the left and right channels.

2 Touch [≫] of X-OVER.

3 Touch [≫] of the speaker to be adjusted.

The screen changes to the X-OVER screen to be adjusted.

4 Adjust the crossover to your preference.

Selecting the Cut-Off Frequency

Touch [◀] or [▶] of FREQ., then select the cut-off frequency (crossover point).

The adjustable bandwidth differs depending on the speaker (channel).

Adjusting the Level

Touch [◀] or [▶] of LEVEL, then adjust the HPF or LPF level.

Adjusting the Slope

Touch [◀] or [▶] of SLOPE, then adjust the HPF or LPF slope.

- When the speaker is set to the "OFF" mode, the X-OVER for that speaker cannot be set. Refer to "Setting the Speakers" (page 44).
- Check the playback frequencies of the connected speakers before adjusting.
- In order to protect the speakers, there is no OFF setting for the subwoofer low pass filter (the slope remains the same).
- The H.P.F. filter cannot be set to OFF (slope OFF) if Tweeter is selected for FRONT1. Or, only the subwoofer is adjustable if STEREO is selected for the subwoofer.

Performing Time Correction Manually (TCR)

BassEngine

A.PROC

Because of the particular conditions inside the vehicle, there can be major differences in the distances between the various speakers and the listening position. It is possible to calculate the optimum correction values and eliminate the time error at the listening position yourself using this function.

Setting item : T.CORR

- 1 Check that Defeat mode is off.
 - 2 Sit in the listening position (the driver's seat, for example) and measure the distance (in meters) between your head and the various speakers.
 - 3 Calculate the difference in distance between the farthest speaker and the other speakers.
- L = (distance of farthest speaker)
- (distance of other speakers)
- 4 Divide the distances calculated for the different speakers by the speed of sound (343 m/s temperature 20°C).

This value is the time correction value for the various speakers.

Concrete examples

Calculating the time correction value for the front left speaker on the diagram below.

Conditions:

Distance between farthest speaker and listening position:
2.25 m (88-3/4")

Distance between front left speaker and listening position:
0.5 m (20")

Calculation:

$$L = 2.25 \text{ m (88-3/4")} - 0.5 \text{ m (20")} = 1.75 \text{ m (68-3/4")}$$

$$\text{Compensation time} = 1.75 \div 343 \times 1000 = 5.1 \text{ (ms)}$$

In other words, setting the time correction value for the front left speaker to 5.1 (ms) sets a virtual distance matching the distance to the farthest speaker.

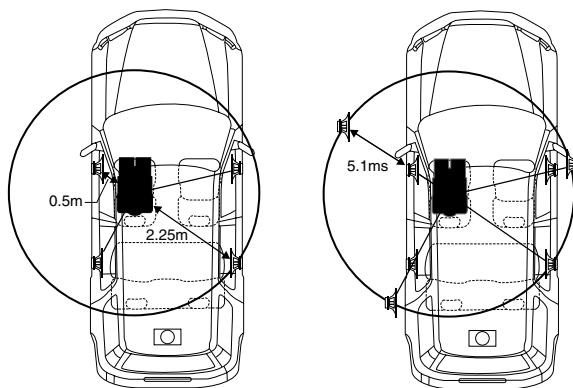

The sound is uneven because the distance between the listening position and the different speakers is different. The difference in the distance between the front left and rear right speakers is 1.75 meters (68-3/4").

Time correction eliminates the difference between the time required for the sound from the different speakers to reach the listening position. Setting the time correction of the front left speaker to 5.1 ms makes it possible to coordinate the distance from the listening position to the speaker.

BassEngine

- 5 Adjust the correction value (0.0 ~ 20.0ms) of a desired speaker by touching the respective [◀] or [▶] button. (1 step = 0.1ms)

A.PROCESSOR

- 5 Touch [◀] or [▶] of T.CORR.
Select L/R or L+R.
L/R: Different adjustment values can be set for the left and right channels.
L+R: Sets the same adjustment values for the left and right channels.
- 6 Touch [≫] of T.CORR.
The T.CORR adjustment screen appears.
- 7 Adjust the time correction value (0.0 ~ 20.0ms) of a desired speaker by touching the respective [◀] or [▶] button. (1 step = 0.05ms)
 - When the speaker is set to the "OFF" mode, the TCR for that speaker cannot be set. Refer to "Setting the Speakers" (page 44).
 - The adjustment value for FRONT2 (Speakers) which is adjusted in time correction, is also applied to the front speakers in "Setting Bass Focus" (page 48).
 - The adjustment (AUTO TCR) cannot be automatically set on this unit.

Phase Switching A.PROC

Setting item : PHASE

Switch the phase (0° or 180°) by touching [◀] or [▶] of the desired speaker.

Graphic Equalizer Adjustments A.PROC

The graphic equalizer allows you to modify the sound using 31 bands each for the front (left and right), rear (left and right) and center speakers. An additional 10 bands are available for the subwoofer. This allows you to customize the sound to suit your taste.

Setting item : G-EQ

1 Select L/R or L+R by touching [◀] or [▶] of G-EQ.

L/R: Different adjustment values can be set for the left and right channels.

L+R: Sets the same adjustment values for the left and right channels.

When parametric EQ is adjusted, this setting will be turned off.

2 Touch [≫] of G-EQ.

The G-EQ list screen appears.

3 Touch [≫] of the desired speaker (channel).

The G-EQ adjustment screen appears.

4 Adjust the G-EQ to your preference.

Adjusting the Level

Touch [◀] or [▶] of the desired frequency to adjust the level.

- When the speaker is set to the "OFF" mode, the graphic equalizer for that speaker cannot be set. Refer to "Setting the Speakers" (page 44).
- Check the playable frequency ranges of the connected speakers before making the equalizer adjustments. If the speaker's playable frequency range is 55 Hz to 30 kHz, for example, adjusting the 40 Hz or 20 Hz band has no effect. Additionally, you may overload and damage the speakers.
- When graphic EQ is adjusted, the adjustment for parametric EQ becomes ineffective.

Parametric Equalizer Adjustments A.PROC

The frequency bands of the graphic equalizer are fixed. This makes it very difficult to correct for undesired peaks and dips at specific frequencies. The parametric equalizer's center frequency can be tuned to these specific frequencies. Then, the bandwidth (Q) and level are fine-tuned, independently, to make the necessary corrections. The parametric equalizer function is an advanced tool for serious audiophiles.

Setting item : P-EQ

1 Select L/R or L+R by touching [◀] or [▶] of P-EQ.

L/R: Different adjustment values can be set for the left and right channels.

L+R: Sets the same adjustment values for the left and right channels.

When graphic EQ is adjusted, this setting will be turned off.

2 Touch [≫] of P-EQ.

The P-EQ list screen appears.

3 Touch [≫] of the desired speaker (channel).

The P-EQ adjustment screen appears.

4 Adjust the P-EQ to your preference.

Selecting the Band

Touch [◀] or [▶] of BAND.
Select the desired band.

Adjusting the Frequency

Touch [◀] or [▶] of FREQ., then adjust the frequency of the selected band.

Adjusting the Level

Touch [◀] or [▶] of LEVEL, then adjust the level of the selected band.

Setting the Bandwidth

Touch [◀] or [▶] of Q.
Select the bandwidth.

- When the speaker is set to the "OFF" mode, the parametric equalizer for that speaker cannot be set. Refer to "Setting the Speakers" (page 44).
- It is not possible to adjust the frequencies of adjacent bands within 7 steps.
- Check the playable frequency ranges of the connected speakers before making the equalizer adjustments. If the speaker's playable frequency range is 55 Hz to 30 kHz, for example, adjusting the 40 Hz or 20 Hz band has no effect. Additionally, you may overload and damage the speakers.
- When the parametric EQ is adjusted, the adjustment for graphic EQ becomes ineffective.

Setting Bass Sound Control

BassEngine **A.PROC**

Setting item : BASS SOUND CONT.

Touch [>>] of BASS SOUND CONT.

The Bass Sound Cont. screen appears.

Setting Bass Compressor **A.PROC**

You can adjust the sound of low frequencies as desired.

Touch [<] or [>] of BASS COMP. to select the desired mode.

Bass sound is emphasized more as the mode is sequentially switched as MODE1 → 2 → 3, offering you vivid low frequencies.

Select OFF when the setting is not necessary.

Touch [RETURN] to return to the previous screen.

Setting Bass Focus **BassEngine** **A.PROC**

Using the previously specified delay number (time difference) allows you to set a time difference between the front-rear/left-right speakers. Namely, it enables a time correction based on your preference. With an initial delay of 0.1 ms (when setting the A.PROCESSOR mode: 0.05 ms) for each of the 0 to 200 steps (when setting the A.PROCESSOR mode: 0 to 400 steps), audible time correction can be achieved.

Set the delay number in the front and rear, and on the right and left of the desired speaker by touching the respective [<] or [>] button.

- Any setting in Bass Focus is applied in time correction, too.
- Touch [RETURN] to return to the previous screen.

Speaker Setup **BassEngine** **A.PROC**

Check the playable frequency range of the speakers (not including the subwoofer) before performing this operation to verify whether the speakers can play low frequencies (of about 80 Hz or less).

- Avoid stopping, pausing, switching the disc, cueing, fast-forwarding or switching the audio channel of this unit while making this adjustment. The setting is canceled if Decode mode is switched.

Setting item : SPEAKER SETUP

Select the speaker characteristic by touching [<] or [>] of the desired speaker setting.

- OFF*¹: When no speaker is connected.
SMALL: When a speaker that cannot play low frequencies (80 Hz or less) is connected.
LARGE*²: When a speaker that can play low frequencies (80 Hz or less) is connected.

- *¹ It is not possible to set the front speakers to "OFF".
*² If the front speakers are set to "SMALL", the rear and center speakers cannot be set to "LARGE."

- The Subwoofer can be set only to ON/OFF.
- If the center speaker is turned "OFF" the center channel's audio signals are added to the audio signals output from the front speakers.
- If you set the speaker response to "OFF," also set the speaker setting to "OFF" (page 44)
- Perform the setup for all the speakers ("Front," "Center," "Rear" and "Subwoofer"). If not, the sound may not be balanced.
- When center is set to "OFF", the setting is ineffective even if center is set with this function.
- Through changing the settings on each speaker, a change in the output of the other speakers may occur due to the setting requirements.
- When using the PRO LOGIC II, if the rear speaker is set to "LARGE", then there will be no output from the subwoofer.
- The PXA-H700 or PXA-H701 can be set according to the playable frequency range of your speakers.

Setting of Dolby Digital **BassEngine** **A.PROC**

Setting item : MULTI CH SETUP

Touch [>>] of MULTI CH SETUP.

The MULTI CH SETUP display appears.

Set the items below as you desire.

Adjusting the acoustic image

(BI-PHANTOM) **BassEngine** **A.PROC**

In most installations, the center speaker must be placed directly between the front passenger and driver. Using this function, the center channel information is distributed to the left and right speakers. This creates an acoustic image simulating a center speaker directly in front of each listener. Adjusting the center width in PL II MUSIC (see "Using the Pro Logic II Mode," page 50), makes this function ineffective.

- *Avoid stopping, pausing, switching the disc, cueing, fast-forwarding or switching the audio channel of this unit while making this adjustment. The setting is canceled if the Decode mode is switched.*

Touch [◀] or [▶] of BI-PHANTOM to adjust the level. The level can be adjusted within the range of -5 to +6 (when setting the A.PROCESSOR mode: -5 dB to +5 dB). The higher the level, the more the position of the center speaker is shifted to the sides. The BI-PHANTOM function is turned off by touching [OFF].

- *This adjustment is effective when the setting of the center speaker to SMALL or LARGE in the speaker setup settings.*
- *This adjustment is ineffective when the speaker is set to CENTER OFF in "Setting the Speakers" (page 44).*

Mixing bass sound to the rear channel

(REAR MIX) **A.PROC**

This function mixes the front channel audio signals to the audio signals output from the rear speakers, improving the sound in the vehicle's rear seat.

- *Avoid stopping, pausing, switching the disc, cueing, fast-forwarding or switching the audio channel of this unit while making this adjustment. The setting is canceled if the Decode mode is switched.*

Touch [◀] or [▶] of REAR MIX to adjust the level. The level can be adjusted in five steps: -6, -3, 0, +3 and +6. The higher the level, the more bass is output from the rear speakers. (The effect differs according to the software (DVD, etc.)) The REAR MIX function is turned off by touching [OFF].

- *This adjustment is ineffective when the rear speaker setup setting is set to "OFF"*
- *For linear PCM signals, the voice is output from the rear speaker regardless of the REAR FILL and REAR MIX setting.*

Achieving powerful high volume sound

(LISTENING MODE) **BassEngine** **A.PROC**

With Dolby Digital, the dynamic range is compressed so that powerful sound can be achieved at regular volume levels. This compression can be canceled to achieve an energetic sound with even greater power, like the sound in a movie theater.

This function works only in the Dolby Digital mode.

Touch [◀] or [▶] of LISTENING MODE to select STD or MAX.

STD: For powerful sound at regular volume levels

MAX.: For powerful sound at high volumes

- *Keep the volume to a level at which sounds outside the vehicle can still be heard.*

Adjusting the speaker levels (OUTPUT LEVEL)

BassEngine **A.PROC**

The test tones help to make the volume adjustments of the different speakers. When levels are equal, a strong sense of presence can be heard from the different speakers at the listening position.

- *Avoid stopping, pausing, switching the disc, cueing, fast-forwarding or switching the audio channel of this unit while making this adjustment. The setting is canceled if the decode mode is switched.*

- 1 Touch [AUTO] of OUTPUT LEVEL.

Test tone output is repeated for each of the different speaker channels. They will be repeated in the order shown below.

If no operation is performed for 2 seconds, the channel switches to the next channel.

Left → Center → Right → Right Surround →
Left surround → Left

- 2 While the test tone is being produced from the speakers, touch [◀] or [▶] of OUTPUT LEVEL balance the output from all the speakers.

- The adjustment range for the different speakers is -6 dB - +6 dB (when setting the A.PROCESSOR mode: -10 dB to +10 dB).
- Adjust based on the front speakers.

- *If a speaker is set to off mode, that speaker's level adjustment cannot be made. Refer to "Speaker Setup" (page 48).*
- *When this setting is mode using Bass Engine, perform this with no disc inserted in the unit.*

Setting the Output Channel (OUTPUT MODE)

BassEngine

The sound output mode of the internal DVD player can be switched between 2CH and 5.1CH.

- *Avoid stopping, pausing, switching the disc, cueing, fast-forwarding or switching the audio channel of this unit while making this adjustment. The setting is canceled if the Decode mode is switched.*

Touch [◀] or [▶] of OUTPUT MODE to select AUTO or STEREO.

AUTO: The sound output mode will automatically be switched between 2CH and 5.1CH according the number of channels available on the disc to be played and the contents of the SETUP items.

STEREO: The sound output mode will exclusively be switched to 2CH regardless of the number of channels on the disc and its SETUP item contents. When STEREO is set, rear and front output is the same.

- *If this setting is switched from AUTO to STEREO, the front speaker setting of SPEAKER SETUP is switched to "LARGE."*
- *Depending on the AUTO or STEREO setting, adjusting BASS/TRE, T.CORR, Bass Sound Cont. contents cannot be made. Also operation cannot be performed.*

Disc	OUTPUT MODE	BASS/TRE	T.CORR	Bass Sound Cont.
2CH	STEREO	○	-	-
MULTI CH DOLBY 2CH	STEREO	○	-	-
DTS 2CH	AUTO	-	○	○

Adjusting the DVD Level A.PROC

The volume (signal level) for Dolby Digital, Dolby PL II, DTS and PCM modes can be set.

Setting item : DVD LEVEL

- Avoid stopping, pausing, switching the disc, cueing, fast-forwarding or switching the audio channel of this unit while making this adjustment. The setting is canceled if the Decode mode is switched.

Adjust the level by touching [◀] or [▶] of the desired adjusting mode.

The level can be adjusted in the range of -5 to +5.

Storing Settings in the Memory

BassEngine A.PROC

Adjustment or setting contents can be stored.

Contents that can be stored vary depends on the audio processor used.

Setting item : USER PRESET

1 Touch [◀] or [▶] of USER PRESET to select any one of the preset buttons (P-1 through P-6).

2 Touch [MEMORY].

The setting contents are stored.

- The stored contents will not be deleted even when the battery power cord is detached.

Recalling the Preset Memory

Touch [◀] or [▶] of A.PROCESSOR to select the preset memory you want to recall from P-1 through P-6.

- It takes a few moment to recall the preset memory.

Using the Pro Logic II Mode

BassEngine A.PROC

Pro Logic processing can be conducted on the music signals recorded on two channels to achieve Dolby Pro Logic II surround sound. For two-channel Dolby Digital and DTS signals, there is also a "REAR FILL" function for outputting the signals of the front channel to the rear channel.

Setting item : DOLBY PLII/REAR FILL

Touch [◀] or [▶] of DOLBY PLII/REAR FILL to select the desired mode.

PL II MOVIE: Suits the stereo TV shows and all programs encoded in Dolby Surround. It improves the sound field directivity to near that of discrete 5.1-channel sound.

PL II MUSIC: Can be used for all stereo music recordings, and provides a wide, deep sound field.

OFF: Turns DOLBY PL II function to OFF.

PANORAMA: Widens the soundstage of the front stereo Image (BassEngine to extend to the surround speakers. only)

If PL II MUSIC is selected, the center width can be adjusted with following operations.

This function offers the optimum vocal position by adjusting the center channel position between the center speaker and the L/R speaker. (The adjustments established in "Adjusting the acoustic image (BI-PHANTOM)" (page 49) are ineffective while this function is activated.)

Touch [◀] or [▶] of CENTER WIDTH CONT. to adjust the level.

The level can be adjusted between 0 to 7. When the level increases, the center channel position moves from the center speaker position to both sides.

Touch [OFF] of CENTER WIDTH CONT. to turn off the center width control.

- The setting can be made only when an external audio processor is connected.

When the Bass Engine mode is set, the level setting is fixed to "3."

- This adjustment is effective when the setting of the center speaker is SMALL or LARGE in the speaker setup settings.
- "REAR FILL" function
Depending on the input signals, the sound may only be output from the front speakers. In this case, the "REAR FILL" function can be used to output signals from the rear speakers as well.
- If REAR FILL is set, 192kHz, 96kHz, etc., contents are down sampled to 48kHz.
- Avoid stopping, pausing, switching the disc, cueing, fast-forwarding or switching the audio channel of this unit while making this adjustment. The setting is canceled if the Decode mode is switched.
- This adjustment is ineffective when the speaker is set to CENTER OFF in "Setting the Speakers" (page 44).
- This function only works with two-channel signals. This operation is ineffective when 5.1-channel DTS or Dolby Digital signals are input.
- If the setting of REAR FILL is made when REAR MIX is ON, sound is unchanged in the rear fill setting because REAR MIX is given priority during 2 channel decoder other than linear PCM.
- For linear PCM signals, the voice is output from the rear speaker regardless of the REAR FILL and REAR MIX setting.
- Touching [RETURN] will return to the previous screen.

Linear PCM Setting A.PROC

The output when playing discs recorded in linear PCM can be set to 2 or 3 channels.

Setting item : PCM MODE

Touch [◀] or [▶] of PCM MODE to select 2 CH or 3 CH.

2CH: 2ch output (L/R)

3CH: 3ch output (L/R/CENTER)

- This adjustment is ineffective when the speaker is set to CENTER OFF in "Setting the Speakers" (page 44).

Navigation System (Optional)

Switching the Navigation Screen (Optional)

If an optional Alpine Navigation System is connected to the IVA-D105, the Navigation screen can be displayed on this unit.

1 Press **SOURCE/⏻**.

The source screen appears on the display.

2 Touch **[NAV.]**.

The Navigation screen is displayed.

The operation is possible with the supplied navigation remote control.

For navigation operation, refer to the Owner's Manual of the navigator.

- While the Navigation selection mode is being selected in "Setting the VISUAL Button" (page 38), the navigation mode will be directly activated.
- Use the "Setting the VISUAL Button" function (page 38), to select "Nav.". The navigation mode becomes directly activated using the VISUAL Button.
- When the Navigation System is on, the audio and visual navigation cuts in.
- For operation, if a navigation system with touch panel operation is connected, refer to the Owner's Manual of the navigation system.

Portable Navigation System Operation (Optional)

An optional Alpine Portable Navigation System is controllable from the unit. For details, refer to the Owner's Manual of the Portable Navigation System.

With using the docking station type (BLACKBIRD Series)

For details on the connectable Portable Navigation, consult your Alpine dealer.

1 Select **EXTPLYR** in "Setting the AUX Mode" (page 37).

2 Mount the Portable Navigation device to the optional docking station.

The connection to the Portable Navigation is recognized by performing steps 1 and 2.

3 Press **SOURCE/⏻**.

The SOURCE selection screen is displayed.

4 Touch **[NAV.]**.

For details, refer to the Owner's Manual of the Portable Navigation System.

Auxiliary Device (Optional)

Operating Auxiliary Devices (Optional)

To operate your devices connected to the AUX terminals on the rear panel of IVA-D105, follow the procedure described below.

WARNING

It is dangerous (and illegal in many states) for the driver to watch the TV/Video while driving the vehicle. The driver may be distracted from looking ahead and an accident could occur.

Install the IVA-D105 correctly so that the driver cannot watch TV/Video unless the vehicle is stopped and the emergency brake is applied.

If the IVA-D105 is not installed correctly, the driver will be able to watch the TV/Video while driving the vehicle and may be distracted from looking ahead and cause an accident. The driver or other people could be severely injured.

To activate your auxiliary devices:

To watch a video source, your vehicle must be parked with the ignition key in the ACC or ON position. To do this, follow the procedure below.

- 1 Bring your vehicle to a complete stop at a safe location. Engage the parking brake.
- 2 Keep pushing the foot brake and release the parking brake once then engage it again.
- 3 When the parking brake is engaged for the second time, release the foot brake.

- For automatic transmission vehicles, place the transmission lever in the Park position.

Now, the locking system for the AUX mode operation has been released. Engaging the parking brake can reactivate the AUX mode, as long as the car's ignition has not been turned off. It is not necessary to repeat the above procedure (1 through 3), of "To activate your auxiliary devices."

Each time the ignition is turned OFF, perform the procedure of "To activate your auxiliary devices."

- If you try to activate the auxiliary device while driving, the display will show the warning-**PICTURE OFF FOR YOUR SAFETY**.

1 Press **SOURCE/⏏**.

The source screen appears on the display.

2 Touch **[AUX]***.

The external input screen is displayed.

* The name which is given as the source name in "Setting the AUX Mode" on page 37 is displayed.

- If the AUX mode is not displayed on the main menu, set AUX IN to ON by following "Setting the AUX Mode" (page 37).
- The display mode changes by touching **[WIDE]**.
For operation, refer to "Switching Display Modes" on page 28.
- When the KCA-410C is connected, the AUX input of the KCA-410C can be used only in INTERRUPT MODE. For details, refer to the KCA-410C Owner's Manual.

Changer (Optional)

Controlling CD Changer (Optional)

An optional 6-disc or 12-disc CD Changer may be connected to the IVA-D105 if it is Ai-NET compatible. With a CD Changer connected to the Ai-NET input of the IVA-D105, the CD Changer will be controllable from the IVA-D105.

If you connect a changer compatible with MP3, you can play CD-ROMs, CD-Rs, and CD-RWs containing MP3 files on the IVA-D105.

Using the KCA-410C (Versatile Link Terminal) multiple changers can be controlled by the IVA-D105.

See the Multi-Changer Selection section for selecting the CD Changers (explained on page 53).

1 Press **SOURCE/⏏**.

2 Touch **[CD CHG]**.

The display changes to the CD changer mode screen.

- The source name in the display changes from CD CHG to USB when "Setting the USB Adapter to ON/OFF" (page 38) is set to ON.

When a 6 Disc CD Changer is connected;

- 1 Touch **[PAGE1/2]***.

The Function Guide display appears.

* When an MP3 compatible CD changer or DVD changer is connected, touch repeatedly until the disc number is displayed.

- 2 Touch any one of the select buttons **[D-1]** through **[D-6]**.
DISC 1 through DISC 6 select the discs from the first disc to 6th disc.

When an MP3 compatible CD changer is connected;

- 1 Touch **[PAGE1/3]** twice to change the Function Guide display.
- 2 Touch any one of the select buttons **[D-1]** through **[D-6]**.
DISC 1 through DISC 6 select the discs from the first disc to 6th disc.

When a 12-Disc CD Changer is connected;

You can select the disc numbers 1 to 6 in the same manner as for 6-disc Changer.

Touch **[PAGE1/3]** twice to select disc numbers 7 to 12.

The function guide display changes so that D-7 through D-12 represent disc numbers 7 to 12.

- After selecting the desired disc, you can operate in the same way as for the CD player. For details, see the CD/MP3/WMA section.
- When an MP3 compatible CD changer is connected, the unit can play discs containing both audio data and MP3 data.
- The DVD changer (optional) is controllable from the IVA-D105 as well as the CD changer.

Multi-Changer Selection (Optional)

When using KCA-410C (Versatile Link Terminal), you can connect two changers.

- 1** In changer mode, touch **[CHG SEL]** or press **BAND** on the unit to select the next changer (connected CD changers only) .
- 2** To operate the selected changer, see “CD/MP3/WMA/AAC” section.

SAT Radio Receiver (Optional)

SAT Receiver: XM or SIRIUS Receiver

When an optional XM or SIRIUS Receiver Box is connected via the Ai-NET bus, the following operations may be performed. However, the XM Receiver and SIRIUS Receiver cannot be connected at the same time.

Receiving Channels with the SAT Receiver (Optional)

About SAT Radio

Satellite Radio* is the next generation of audio entertainment, with over to 100 digital channels. For a small monthly fee, subscribers can hear crystal-clear music, sports, news and talk, coast-to-coast via satellite. For more information, visit XM’s website at www.xmradio.com., and SIRIUS’ website at www.sirius.com.

To receive SAT Radio, the separately sold XMDirect™ or SIRIUS Satellite Radio Tuner and an appropriate Ai-NET Interface Adapter will be required. For details, consult you nearest ALPINE dealer.

* XM and its corresponding logos are trademarks of XM Satellite Radio Inc.

* SIRIUS and its corresponding logos are trademarks of SIRIUS Satellite Radio Inc.

- The SAT Receiver controls on the IVA-D105 are operative only when a SAT Receiver is connected.

1 Press SOURCE/ϕ.

The SOURCE selection screen is displayed.

2 Touch [XM] or [SIRIUS].

The XM or SIRIUS main screen display appears.

3 Press BAND to select the desired band.

XM radio:

XM-1 → XM-2 → XM-3 → XM-1

SIRIUS radio:

SIRIUS-1 → SIRIUS-2 → SIRIUS-3 → SIRIUS-1

4 Touch [TUNE] to select the channel number tuning.

Each time it is pressed, the tuning mode is changed.
channel number tuning ↔ channel name tuning

5 Touch [◀ NO.] / [NO. ▶] or [◀ NAME] or [NAME ▶] to select the desired channel. Holding either button down will change channels continuously.

- To customers when connecting the SIRIUS Tuner Box:
For detailed functions, refer to the SIRIUS Tuner Box installation manual.
- The band can also be changed by touching [BAND] on the function guide.
- For SIRIUS Setup operation, refer to page 57-58.

Tuning in to Categorized Programs

You can listen to programs categorized to the same group one after another.

In the XM or SIRIUS mode, touch CATEGORY [▼] or [▲] to select a desired category.

The first channel of the selected category is tuned.

- If the desired category program is not found, the “-----” is displayed for 2 seconds, then the receiving program is restored.

Changing the Display

Text information, such as the channel name, artist name/feature, and song/program title, is available with each XM or SIRIUS channel. The unit can display this text information as explained below.

Touch [INFO.] on the XM or SIRIUS mode main screen.

Each time you touch this button, the display changes as shown below.

XM mode:

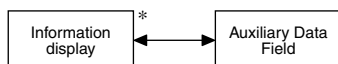

SIRIUS mode:

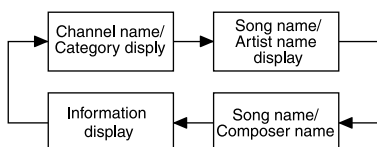

* Channel name, category, title name, etc., are displayed in one screen.

Checking the SAT Radio ID Number

A unique Radio ID number is required to subscribe to SAT Radio programming. Each third party XM or SIRIUS radio comes with this number.

XM Radio:

This number is an 8 character alphanumeric. It is printed on a label found on the SAT Receiver.

SIRIUS Radio:

This number is a 12-digit numeric number. It is printed on a label found on the SAT Receiver.

It can also be displayed on the screen of the IVA-D105 in the following way.

1 While receiving SAT Radio, touch [◀ NO.] or [NO. ▶] to select channel '0' for XM and channel "255" for SIRIUS.

The unit display the ID number.

2 The unit displays the ID number.

3 To cancel the ID number display, change the channel.

- You cannot use “O,” “S,” “I,” or “F” for the ID Number. (XM radio Receiver only)
- You can check the ID number printed on a label on your third party, SAT Radio Receiver package.

Storing Channel Presets

1 Touch [PAGE1/3] after selecting a desired band.

The Function Guide is switched.

2 Touch and hold any one of the preset buttons [P-1] through [P-6] for at least 2 seconds. The selected channel is stored.

3 Repeat the procedure to store up to 5 other channels onto the same band.

To use this procedure for other bands, simply select the desired band and repeat the procedure.

A total of 18 channels can be stored in the preset memory (6 channels for each band; XM1, XM2 and XM3 or SIRIUS1, SIRIUS2 and SIRIUS3).

- If you store a channel in a preset already being used, the current channel will be replaced with the new one.

Receiving Stored Channels

1 Touch [PAGE1/3] after selecting a desired band.

The Function Guide is switched.

2 Touch any one of the preset buttons [P-1] through [P-6] that has your desired satellite channel in memory.

Search Function (XM mode)

- 1 In XM mode, touch [☐].
The category title list is displayed.

Screen example for category search list

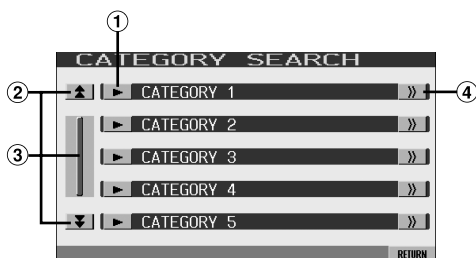

- ① Touch [▶] to receive the selected category channel directly.
- ② Scrolls the page list up or down.
(Displayed when the list items cannot be displayed entirely.)
- ③ Scrolls the list item by item.
Touching and holding will scroll continuously.
- ④ [>>] is displayed if there is a hierarchical list.
Touch [>>] to change the channel name search screen of the selected category.

Screen example for channel name search list

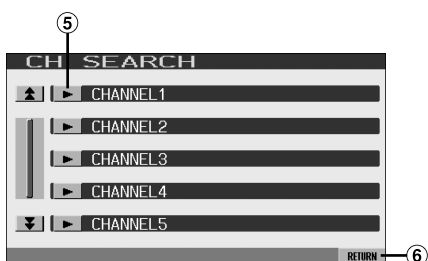

- ⑤ The selected channel is received.
- ⑥ Returns to the category search list.

- 2 Touch [▶] of the selected Category or Channel name.

The channel in the selected category is tuned.

- When the channel number is selected, the channel is displayed in order of channel number. When the channel name is selected, the channel is displayed in alphabetical order.

Search Function (SIRIUS mode)

- 1 Touch [☐] in the SIRIUS mode.
SEARCH menu list is displayed.

- 2 Select the desired SEARCH menu.

Searching by Category

- 1 Touch [>>] of CATEGORY.
The CATEGORY search screen is displayed.

- Touch [▶] to receive the selected category channel directly.
- 2 Touch [>>] to change to channel name search screen of the selected category.
- 3 Touch [▶] to receive the selected channel name.

Searching by Channel Name

- 1 Touch [>>] of CHANNEL.
The CH search screen is displayed.
- 2 Touch [▶] to receive the selected channel name.

Searching by Artist Name

- 1 Touch [>>] of ARTIST.
The artist name of each channel is displayed in order of channel number.
- 2 Touch [▶] of the desired artist.
The channel of the selected artist being broadcast is received.

Searching by Song Name

- 1 Touch [>>] of SONG.
The song name of each channel is displayed in order of channel number.
- 2 Touch [▶] of the desired song.
The channel of the selected song being broadcast is received.

Selecting the Channel directly

You can directly select the channel number on the display of the numeric keypad.

- 1 Touch [PAGE1/3] twice in the XM or SIRIUS mode.
The function guide appears.

- 2 Touch [10KEY].
The numeric keypad input screen is displayed.

- 3 Touch to input the channel number.

- 4 Touch [ENT].
The selected channel is received.

Receiving Weather or Traffic information from SAT Radio

1 Touch [PAGE1/3]* twice in the XM or SIRIUS mode.
The function guide appears.

* Touch ones during the SIRIUS mode.

2 Touch and hold [BAND] for at least 2 seconds.

The received weather or traffic channel is stored.

3 Press and hold BAND/SAT for at least 2 seconds on the unit.

The stored Weather or Traffic channel is recalled.

4 Press and hold BAND/SAT for at least 2 seconds on the unit.

Returns to the normal mode.

- Stored channels can also be recalled by pressing and holding BAND/SAT for at least 2 seconds on the unit, even in modes other than XM or SIRIUS mode.
- Channels other than Weather. or Traffic information can also be stored and recalled.

Storing the desired Song/Artist (SIRIUS mode only)

A maximum of 30 desired songs and artists (including sports teams) can be stored on the unit. When stored, a message is displayed to announce when stored songs are being broadcast on another radio station, should you wish to listen to it. (Refer to "Receiving the stored information" on page 56.)

1 Touch [PAGE1/3] twice times to store an artist or song currently being received.

The function guide is changed.

2 Touch [MEMORY].

The SONG ALERT or ARTIST ALERT SETUP is displayed.

3 Touch [▶] of the SONG or ARTIST in the list you want to store.

The selected songs and artists are registered.

- "UNABLE TO STORE" appears in the display if there is no song title information and it cannot be stored.
- If there is no memory, "MEMORY FULL" is displayed for 2 seconds, and then the display changes to the ALERT list. Touch [▶] of the song or artist you want to rewrite. message is displayed. If "OK" is touched, the song or artist is rewritten and stored. If "NO" is touched, it is canceled.
- If [MEMORY] is touched and held for at least 2 seconds, the display changes to the ALERT SETUP screen.
Touch [◀] or [▶] of the channel you want to set. If you want ALERT interruption, set to ON, if not, set to OFF.
- If Sports/team is stored, touch [A.LIST] to change to the SIRIUS SETUP screen, then touch [≫] of ALERT LIST. Touch [◀] or [▶] of the channel to be set, and set the receiving interruption to ON/OFF.

Storing favorite Sports Teams (SIRIUS mode only)

One team from each league can be stored on the unit. When stored, their game status and results are announced when other stations are being listened to, and if you wish, you can go to the station where the game is being broadcast. (Refer to "Receiving the stored information" on page 56.)

1 Touch [PAGE1/3] twice to store a game currently being broadcast.

The function guide is changed.

2 Touch [MEMORY].

The display changes to the GAME ALERT screen. Both the selected team and opponent team names are displayed.

3 Touch [▶] of the team you want to store.

The selected team is registered.

- "UNABLE TO STORE" will be displayed if the above information cannot be stored.
- Touch [A. LIST] to change to the SIRIUS SETUP screen, and then touch [≫] of ALERT LIST. Set the receiving interruption type (INITIAL/SCORE/OFF) by touching [◀] or [▶] of the channel you want to set.

Receiving the stored information (SIRIUS mode only)

When stored sports team, song or artist is being broadcast, a message appears and it is announced. The broadcasting channel can be received.

1 When stored information is broadcast, after displaying "SONG ALERT", "ARTIST ALERT" or "GAME ALERT," the screen changes to the list display.

2 Touch [▶] of the channel on the list you want to receive.

The display changes to the selected channel and the channel is received.

- If [RETURN] is touched, return to the previous screen.
- If no operation is performed for 10 seconds the screen returns to the main menu.

Offset Playback Function (SIRIUS mode only)

If the SIRIUS radio is interrupted by another source (e.g., telephone call, etc), the current channel is saved using the memory playback function. At the end of the interruption, use this function to listen to the part of the broadcast that was missed. Channels can be stored continuously for up to 48 minutes.

- 1 Touch [PAGE1/3] twice.**
The function guide appears.
- 2 Touch [▶/||] while receiving the broadcasting program you want to store.**
The "PAUSED" indicator lights up.
- 3 Touch [▶/||] again during PAUSE.**
The "MEMORY MODE" indicator lights up and offset playback commences.
 - The time difference between the real broadcasting time and the offset playback time is displayed.
- 4 If [■] is touched, offset playback stops and the display returns to the main screen.**
 - To fast reverse, touch and hold [◀◀]. and to fast forward, touch and hold [▶▶].
 - Touching [◀◀] or [▶▶] will move a track up/down.

SIRIUS Setup

SIRIUS Setup Operation

The operation can be performed when the optional SIRIUS receiver box is connected.

The following steps 1 to 3 are common operations to each "Setting item" of SIRIUS Setup. Refer to each section for details.

- 1 Touch [A.LIST] on the SIRIUS main screen.**
The SIRIUS SETUP screen is displayed.

- 2 Select the desired setting item.**

Setting items:

ALERT LIST / SONG ALERT / GAME ALERT / MAY GAME ZONE

- 3 Touch [RETURN] to return to the previous display.**

Setting the announcement individually for a Song / Artist / Sports Team

The following operation determines whether announcement is set or not for a stored Song, Artist or Sports team's information is broadcast by another radio station.

Setting items: ALERT LIST

- 1 Touch [➤] of the ALERT LIST.**
The display changes to the ALERT LIST screen.
- 2 Touch [▶] of the desired song(s), artist(s), or team.**
- 3 Touch [◀] or [▶] of the channel you want to receive ALERT announcement, to set to ON.**
Set to OFF if you do not want an announcement.
Select the announcement type for GAME ALERT.

Setting ON/OFF of all Songs/Artists Interruption

Determines whether the received announcement of all stored Songs/Artists is set or not.

Setting items: SONG ALERT

ON: Set to receive announcements.
OFF: No announcements.

Setting the sports team announcement type

The following operation sets the announcement type for a stored sports team.

Setting items: **GAME ALERT**

- 1 Touch [◀] or [▶] of GAME ALERT and set to ON.**
The received announcement for all stored sports teams is set. If OFF is selected, no announcements will be made.
 - 2 Touch [≫] of GAME ALERT.**
The display changes to the GAME ALERT SETUP screen.
 - 3 Touch [≫] of the favorite league.**
The display changes to the team list of the selected league.
 - 4 Touch [▶] of the favorite team.**
[▶] changes to orange (highlight), and the selection key is displayed.
 - 5 Touch [◀] or [▶] to of the desired announcement type.**
INITIAL: Announces when a game starts.
SCORE: At the beginning of the game, the announcement interrupts; announces every time the score changes.
- Select "NONE" on the list if you do not want to store in memory. ALERT interruption does not occur.

Setting the Sports Team Display

Set the game status and result information display of a stored team.

Setting items: **MY GAME ZONE**

- ON: Displays the game's score, status, etc..
- OFF: Displays only the opponent team name.

iPod® (Optional)

An iPod® can be connected to the IVA-D105 by using the proprietary ALPINE FULL SPEED™ connection cable (KCE-422i). When the IVA-D105 is connected by using the cable, the controls on the iPod are not functional.

About iPod usable with this unit

The unit can be used with fourth generation and above iPod, iPod photo, iPod minis or iPod nano. iPod Shuffle cannot be used, however.

- Touch wheel or scroll wheel type iPods without the dock connector cannot be connected to the unit.
- The unit can be used with the following iPod versions. Correct function of earlier versions cannot be guaranteed.

Fourth generation iPod: Ver. 3.1.1

Fifth generation iPod: Ver. 1.1.2

iPod photo: Ver. 1.2.1

iPod mini: Ver. 1.4.1

iPod nano: Ver. 1.2

- The unit cannot be used with the software versions earlier than "2006-06-28". For details about "iPod Software Update," refer to the iPod Instruction Manual.

Playback

- 1 Press SOURCE/⏻.**
The SOURCE selection screen is displayed.
- 2 Touch [iPod].**
The display shows the iPod mode screen.
- 3 Touch [◀◀] or [▶▶] to select the desired song.**

Return to the beginning of the current song:

Touch [◀◀].

Fast reverse:

Touch and hold [◀◀].

Advance to the beginning of the next song:

Touch [▶▶].

Fast forward:

Touch and hold [▶▶].

- 4 To pause playback, touch [▶/||].**
Touching [▶/||] again will resume playback.
- If a song is playing on the iPod when it is connected to the IVA-D105, it will continue playing after the connection.
 - If the artist, album or song name, created in iTunes, has too many characters, songs may not be played back when connected to the IVA-D105. Therefore, a maximum of 250 characters is recommended. The maximum number of characters for the head unit is 128 (128 byte).
 - Some characters may not be correctly displayed.
 - "NO SUPPORT" is displayed when text information is not compatible with the IVA-D105.

Searching for a desired Song

An iPod can contain hundreds of songs. By keeping these songs organized in playlists, the IVA-D105 can use these to ease song searches.

Using the search mode's individual hierarchy, you can narrow down your search as shown in the table below.

Hierarchy 1	Hierarchy 2	Hierarchy 3	Hierarchy 4
Playlist	Song	—	—
Artist*	Album*	Song	—
Album*	Song	—	—
Song	—	—	—
Genre*	Artist*	Album*	Song
Composer*	Album*	Song	—
Podcast	Episode	—	—

For example: Searching by Artist name

The following example explains how an ARTIST search is performed. Another search mode can be used for the same operation, although the hierarchy differs.

Searching by artist name

1 Touch [□].

The search mode is activated, and the search list screen appears.

2 Touch [>>>] of ARTIST.

The ARTIST search screen is displayed.

3 Select the desired artist.

To play back the artist directly

- 1 Touch [▶] next to the artist's name.
All songs of the selected artist are played back.

To search for the album of an artist

- 1 Touch [>>>] of the selected artist.
The ALBUM search screen of the selected artist is displayed.
- 2 Touch [▶] next to the desired album's name.
All songs of the selected album are played back.

To search for a song in the album of an artist

- 1 Touch [>>>] of the desired album in "To search for the album of an artist" in step 2.
The SONG search screen of the selected album is displayed.
 - 2 Touch [▶] next to the desired song's name.
The selected song is played back.
- Touching [▶] of ALL will play back all songs in the list when you are in a hierarchy with an asterisk* (see table above). ("ALL" is displayed if the display is less than 4 items.)
 - Touching [>>>] of ALL will display the search list in the next hierarchy. ("ALL" is displayed if the display is less than 4 items.)
 - In search mode, you can jump to an assigned position by touching the direct search bar for quick search. For details, refer to "Direct Search Function" (page 59).

Direct Search Function

The unit's direct search function can be used to search for an album, song, etc., more efficiently. In PLAYLIST/ARTIST/ALBUM/SONG/GENRE/COMPOSER/PODCAST mode, you can quickly target any song.

Example of ALBUM search screen

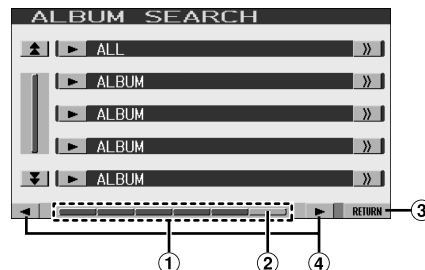

- ① Direct search bar
- ② Active point: The present selection position is displayed.
- ③ Returns to the previous screen.
- ④ Touching [◀] or [▶] will move the active point by 1/6 each. Touching and holding [◀] or [▶] will move the active point continuously.

1 In search mode, touch anywhere on the Direct search bar to step through items, or slide left or right to continuously scroll through items. The search list display also changes according to the selected song position.

<SONG search example>

If there are 100 songs in your iPod, all the songs are shown on the direct search bar.

Suppose the song you are searching for is located at around the 50th song of your library: touch around the middle (50%) of the direct search bar to jump to the song you desire.

Selecting Playlist/Artist/Album/Genre/Composer/Podcast

Playlist/Artist/Album/Genre/Composer/Podcast can be easily changed. For example, if you listen to a song from a selected album, the album can be changed.

1 Touch [▼] or [▲] to select the desired Playlist/Artist/Album/Genre/Composer/Podcast.

- If search selection mode is not activated, a SONG search is not possible.
- During shuffle (M.I.X.) playback, this operation is not possible.
- If Playlist/Artist/Album/Genre/Composer are not searched, this operation is not possible.

Random Play Shuffle (M.I.X.)

The Shuffle function of the iPod is displayed as M.I.X. on the IVA-D105.

Shuffle ALL:

Shuffle ALL plays all songs in the iPod randomly. Any one song does not play back again until all songs have been played back.

Shuffle Albums:

Album shuffle playback plays back all songs in order, then randomly selects the next album. All songs of that album are played back in order, and so on. Any one album is played just once.

Shuffle Songs:

Song shuffle randomly plays back certain selected songs. Any one song plays back just once until all songs have been played back.

1 Touch [ALL .

The songs will be played back in random sequence.

M.I.X. SONGS ↔ (off)
(Shuffle ALL)

Touch [] after touching [PAGE1/2].

→ M.I.X. ALBUMS → M.I.X. SONGS → (off)
(Shuffle Albums) (Shuffle Songs)

2 To cancel M.I.X. play, touch [ALL] or [.

- For details of the search mode, refer to "Searching for a desired Song" (page 59).
- If a song is selected in the album search mode before selecting Shuffle (M.I.X.), the songs will not play back randomly even when Shuffle album is selected.

Repeat Play

Only Repeat One is available for the iPod.

Repeat One: A single song is repeatedly played back.

1 Touch [PAGE1/2].



The function guide is displayed.

2 Touch [.

The file will be played repeatedly.

RPT ↔ (off)
(Repeat One) (Repeat the list being played back)

3 To cancel repeat play, touch [.

- During repeat playback, no other songs are selectable by touching [] or [.

Remote Control

Controls on Remote Control

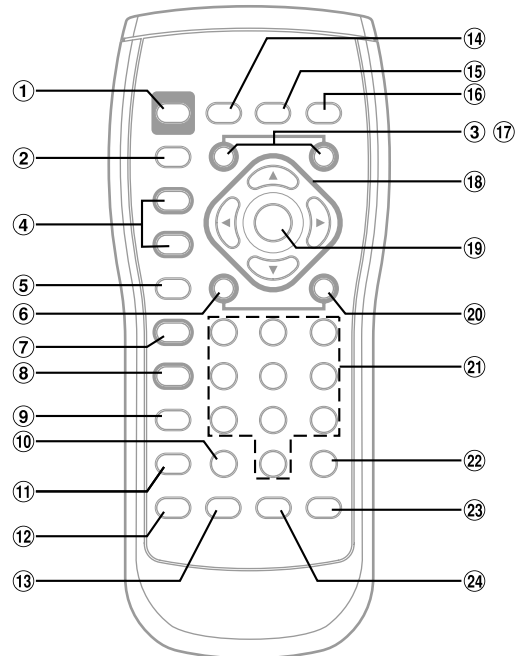

- PWR button**
Turns the power ON and OFF.
- SRC Button**
Selects the audio source.
- DN Button**
Radio mode: Selects, in descending order, stations programmed into the radio's presets.
MP3/WMA/AAC mode:
Folder Select (DN) Button selects the folder.
Changer mode:
DISC Select (DN) Button selects a disc in descending order.
- VOLUME ▲ / ▼ Button**
Increase or decreases the volume level.
- RETURN Button**
DVD/Video CD (PBC ON) mode: Returns to the previous display. (Does not return in some discs.)

⑥ **◀◀ button**

Radio mode: SEEK (DN) button

CD /Changer mode:

Press the button to go back to the beginning of the current track. Press and hold to fast reverse.

MP3/WMA/AAC mode:

Press the button to go back to the beginning of the current file. Press and hold to fast reverse.

DVD Video/DVD-VR/DVD Audio (VCAP)/Video CD:

- Move to the desired position on the disc.
- During playback, press and hold for more than 1 second to reverse the disc at double speed. Hold for more than 5 seconds to reverse the disc at 8 times the normal speed. Hold for more than 10 seconds to reverse the disc at 21 times the normal speed.

DVD mode:

- When pressed and held in while in the pause mode, the disc is played in reverse slow motion at 1/8th the normal speed. When held in for 5 more seconds, the reverse slow motion speed switches to 1/2 the normal speed.
- The picture is reversed by one frame each time the button is pressed in the pause mode.

⑦ **▶/|| Button**

Radio mode: Chooses the tuning mode.

By pressing it more than 2 seconds, Automatic Memory will be operated.

Disc mode: Switches between play and pause.

- *SEARCH Button: Not used.*

⑧ **■ button**

Performs stop.
DVD/Video CD:

Pressing once stops the PRE stop; Pressing twice sets stop.

⑨ **MENU Button**

DVD Video mode:

Shows the menu display.

Video CD: Turns PBC ON/OFF.

⑩ **CLR Button**

Removes numbers (one character at a time) that have been selected and input.

Press and hold for 2 seconds. All the characters which were selected and input are erased.

⑪ **DISP/TOP M. Button**

DVD Video/DVD-VR/Video CD mode:

Shows playback status (only when car is stopped).

DVD Video/DVD Audio (VCAP) mode:

By pressing more than 2 seconds, shows the top menu display.

⑫ **SETUP Button**

Not used.

⑬ **AUDIO Button**

DVD/Video CD mode: Switches audio.

⑭ **BAND Button**

Radio mode: Changes the band.

Changer mode:

Switches the disc mode.
(when an optional KCA-410C is connected)

DVD mode: While playing a DVD, the display mode is switched (only when car is stopped).

⑮ **A.PROC Button**

When an external audio processor is connected:

Press the button to display the audio processor setting screen.

When an external audio processor is non-connected:

Press the button to display the BassEngine mode screen.

⑯ **MUTE Button**

Lowers the volume by 20 dB instantly. Press the button again to cancel.

By pressing the button for more than 2 seconds, the monitor opens or closes.

⑰ **UP Button**

Radio mode: Selects, in ascending order, stations programmed into the radio's presets.

MP3/WMA/AAC mode:

Folder Select (UP) Button to selects the folder.

Changer mode:

DISC Select (UP) Button selects a disc in ascending order.

⑱ **▲, ▼, ◀, ▶**

DVD Video/DVD Audio (VCAP) mode:

Selects an item displayed in the screen.

⑲ **ENT. Button**

Enters the selected item.

⑳ **▶▶| button**

Radio mode: SEEK (UP) button

CD/Changer mode:

Press the button to advance to the beginning of the next track. Press and hold to fast forward.

MP3/WMA/AAC mode:

Press the button to advance to the beginning of the next file. Press and hold to fast forward.

DVD Video/DVD-VR/DVD Audio (VCAP)/Video CD:

- Move to the desired position on the disc.
- During playback, press and hold for more than 1 second to forward the disc at double speed. Hold for more than 5 seconds to forward the disc at 8 times the normal speed. Hold for more than 10 seconds to forward the disc at 21 times the normal speed.

DVD Video/DVD-VR/Video CD:

- When pressed and held in while in the pause mode, the disc is played in slow motion at 1/8th the normal speed. When held in for 5 more seconds, the slow motion speed switches to 1/2 the normal speed.
- The picture is forwarded by one frame each time the button is pressed in the pause mode.

⑳ **Numeric Keypad**

Inputs numbers.

㉑ **MONITOR Button**

Not used.

㉒ **ANGLE Button**

DVD Video/Audio (VCAP) mode:

Switches the angle of the picture.

㉓ **SUBTITLE button**

DVD mode: Switches the subtitle.

- *The SETUP operation of the unit cannot be carried out from the remote control.*
- *Some operations may not be possible depending on the disc.*

When Using the Remote Control

- **Point the remote control at the remote sensor within about 2 meters.**
- **It may not be possible to operate the remote control if the remote control sensor is exposed to direct sunlight.**
- **The remote control is a small, lightweight precision device. To avoid damage, short battery life, operational errors and poor response, observe the following.**
 - Do not subject the remote control to excessive shock.
 - Do not put in a trouser pocket.
 - Keep away from food, moisture and dirt.
 - Do not place in direct sunshine.

Battery Replacement

Battery type: CR2025 battery or equivalent.

1 Opening the battery case

Slide out the battery cover while firmly pressing in the direction of the arrow.

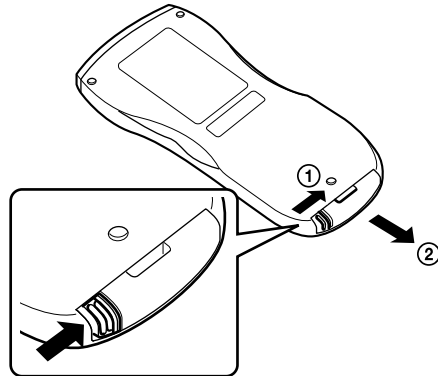

2 Replacing the battery

Put the battery in the case with the (+) indication upward as shown in the illustration.

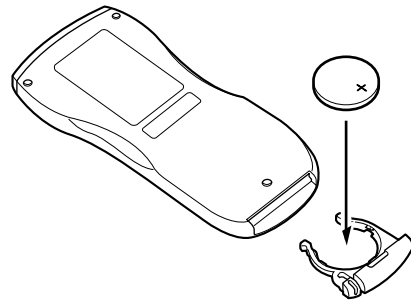

- *Placing a battery in backwards way may cause a malfunction.*

3 Closing the cover

Slide the cover as illustrated until a click is heard.

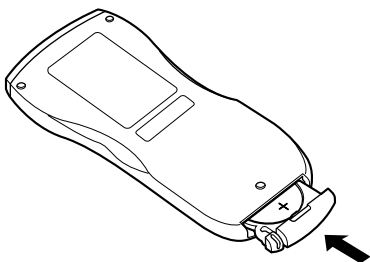

Warning

DO NOT OPERATE ANY FUNCTION THAT TAKES YOUR ATTENTION AWAY FROM SAFELY DRIVING YOUR VEHICLE.

Any function that requires your prolonged attention should only be performed after coming to a complete stop. Always stop the vehicle in a safe location before performing these functions. Failure to do so may result in an accident.

Information

About DVDs

Music CDs and DVDs have grooves (tracks) in which the digital data is recorded. The data is represented as microscopic pits recorded into the track – these pits are read by a laser beam to play the disc. On DVDs, the density of the tracks and pits is twice that of CDs, so DVDs can contain more data in less space.

CDs

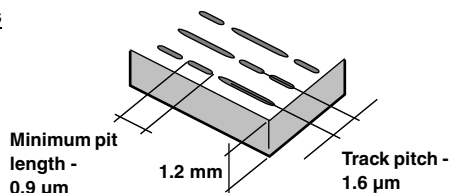

DVDs

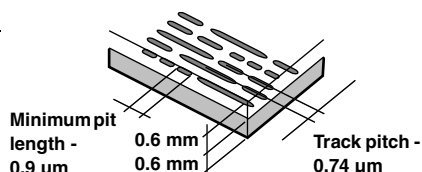

A 12 cm disc can contain one movie or about four hours of music.

In addition, DVDs provide sharp picture quality with vivid colors thanks to a horizontal resolution of over 500 lines (compared to less than 300 for VHS tape).

In addition, DVDs offer a variety of functions.

Multiple audio* (page 25)

Movies can be recorded in up to eight languages. The desired language can be selected from the unit.

Subtitles function* (page 25)

Movies can include subtitles in up to 32 languages. The desired subtitle language can be selected from the unit.

Multi angle function* (page 25)

When the DVD contains a movie shot from multiple angles, the desired angle can be selected from the unit.

Multi story function*

With this function, a single movie includes various story lines. You can select different story lines to view various versions of the same movie.

Operation differs from disc to disc. Story line selection screens including instructions appear during the movie. Just follow the instructions.

* The functions audio languages, subtitle languages, angles, etc., differ from disc to disc. For details, refer to the disc's instructions.

Terminology

Dolby Digital

Dolby Digital is a digital audio compression technology developed by Dolby Laboratories that allows large quantities of audio data to be efficiently recorded on discs. It is compatible with audio signals from mono (1 channel) all the way up to 5.1-channel surround sound. The signals for the different channels are completely independent, and since the sound is high quality digital there is no loss of sound quality.

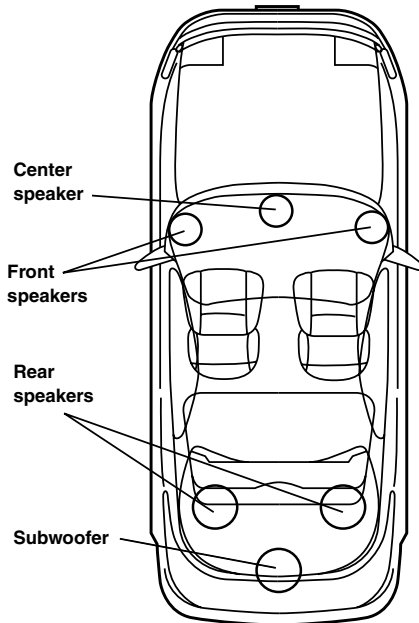

**Speaker layout for enjoying
Dolby Digital sound/DTS sound**

DTS

This is a home-use digital sound format of the DTS Sound System. This is a high quality sound system, developed by DTS, Inc. for use in movie theaters.

DTS has six independent sound tracks. The theater presentation is fully realized in the home and other settings. DTS is the abbreviation for Digital Theater System.

** To enjoy DTS surround sound you need the separately sold DTS digital audio processor (PXA-H700, etc.). The DVD video software must also have a DTS sound track.*

The IVA-D105 has a built-in DTS 2-channel audio decoder. Analog audio outputs are available.

Dolby Pro Logic II

Dolby Pro Logic II plays 2-channel sources in 5 channels over the entire frequency range.

This is done with an advance, high sound quality matrix surround decoder which draws out the spatial properties of the original recording without adding any sounds to or changing the sound of the source.

** The separately sold digital audio processor (PXA-H700, etc.) is required to enjoy Dolby Pro Logic II surround sound.*

Linear PCM audio (LPCM)

LPCM is a signal recording format used for music CDs.

Whereas music CDs are recorded at 44.1 kHz/16 bits, DVDs are recorded at 48 kHz/16 bits to 96 kHz/24 bits, thereby achieving higher sound quality than music CDs.

Rating levels (parental lock)

This is a function of the DVD for restricting the viewing age as stipulated by laws in different countries. The way in which viewing is restricted differs from DVD to DVD. Sometimes the DVD cannot be played at all, other times certain scenes are skipped, and other times certain scenes are replaced with other scenes.

List of Language Codes

(For details, see page 30.)

Abbreviation	Code	Language	Abbreviation	Code	Language	Abbreviation	Code	Language
AA	6565	Afar	IE	7369	Interlingue	RN	8278	Kirundi
AB	6566	Abkhazian	IK	7375	Inupiak	RO	8279	Romanian
AF	6570	Afrikaans	IN	7378	Indonesian	RU	8285	Russian
AM	6577	Amharic	IS	7383	Icelandic	RW	8287	Kinyarwanda
AR	6582	Arabic	IT	7384	Italian	SA	8365	Sanskrit
AS	6583	Assamese	IW	7387	Hebrew	SD	8368	Sindhi
AY	6589	Aymara	JA	7465	Japanese	SG	8371	Sangho
AZ	6590	Azerbaijani	JI	7473	Yiddish	SH	8372	Serbo-Croatian
BA	6665	Bashkir	JW	7487	Javanese	SI	8373	Singhalese
BE	6669	Byelorussian	KA	7565	Georgian	SK	8375	Slovak
BG	6671	Bulgarian	KK	7575	Kazakh	SL	8376	Slovenian
BH	6672	Bihari	KL	7576	Greenlandic	SM	8377	Samoan
BI	6673	Bislama	KM	7577	Cambodian	SN	8378	Shona
BN	6678	Bengali, Bangla	KN	7578	Kannada	SO	8379	Somali
BO	6679	Tibetan	KO	7579	Korean	SQ	8381	Albanian
BR	6682	Breton	KS	7583	Kashmiri	SR	8382	Serbian
CA	6765	Catalan	KU	7585	Kurdish	SS	8383	Siswati
CO	6779	Corsican	KY	7589	Kirghiz	ST	8384	Sesotho
CS	6783	Czech	LA	7665	Latin	SU	8385	Sundanese
CY	6789	Welsh	LN	7678	Lingala	SV	8386	Swedish
DA	6865	Danish	LO	7679	Laothian	SW	8387	Swahili
DE	6869	German	LT	7684	Lithuanian	TA	8465	Tamil
DZ	6890	Bhutani	LV	7686	Latvian, Lettish	TE	8469	Telugu
EL	6976	Greek	MG	7771	Malagasy	TG	8471	Tajik
EN	6978	English	MI	7773	Maori	TH	8472	Thai
EO	6979	Esperanto	MK	7775	Macedonian	TI	8473	Tigrinya
ES	6983	Spanish	ML	7776	Malayalam	TK	8475	Turkmen
ET	6984	Estonian	MN	7778	Mongolian	TL	8476	Tagalog
EU	6985	Basque	MO	7779	Moldavian	TN	8478	Setswana
FA	7065	Persian	MR	7782	Marathi	TO	8479	Tonga
FI	7073	Finnish	MS	7783	Malay	TR	8482	Turkish
FJ	7074	Fiji	MT	7784	Maltese	TS	8483	Tsonga
FO	7079	Faroese	MY	7789	Burmese	TT	8484	Tatar
FR	7082	French	NA	7865	Nauru	TW	8487	Twi
FY	7089	Frisian	NE	7869	Nepali	UK	8575	Ukrainian
GA	7165	Irish	NL	7876	Dutch	UR	8582	Urdu
GD	7168	Scots Gaelic	NO	7879	Norwegian	UZ	8590	Uzbek
GL	7176	Galician	OC	7967	Occitan	VI	8673	Vietnamese
GN	7178	Guarani	OM	7977	(Afan) Oromo	VO	8679	Volapuk
GU	7185	Gujarati	OR	7982	Oriya	WO	8779	Wolof
HA	7265	Hausa	PA	8065	Punjabi	XH	8872	Xhosa
HI	7273	Hindi	PL	8076	Polish	YO	8979	Yoruba
HR	7282	Croatian	PS	8083	Pashto, Pushto	ZH	9072	Chinese
HU	7285	Hungarian	PT	8084	Portuguese	ZU	9085	Zulu
HY	7289	Armenian	QU	8185	Quechua			
IA	7365	Interlingua	RM	8277	Rhaeto-Romance			

List of Country Codes

(For details, see page 30.)

Abbreviation	Code	Country	Abbreviation	Code	Country	Abbreviation	Code	Country
AD	6568	Andorra	DM	6877	Dominica	KI	7573	Kiribati
AE	6569	United Arab Emirates	DO	6879	Dominican Republic	KM	7577	Comoros
AF	6570	Afghanistan	DZ	6890	Algeria	KN	7578	Saint Kitts and Nevis
AG	6571	Antigua and Barbuda	EC	6967	Ecuador	KP	7580	Korea, Democratic People's Republic of
AI	6573	Anguilla	EE	6969	Estonia			
AL	6576	Albania	EG	6971	Egypt	KR	7582	Korea, Republic of
AM	6577	Armenia	EH	6972	Western Sahara	KW	7587	Kuwait
AN	6578	Netherlands Antilles	ER	6982	Eritrea	KY	7589	Cayman Islands
AO	6579	Angola	ES	6983	Spain	KZ	7590	Kazakhstan
AQ	6581	Antarctica	ET	6984	Ethiopia	LA	7665	Lao People's Democratic Republic
AR	6582	Argentina	FI	7073	Finland			
AS	6583	American Samoa	FJ	7074	Fiji	LB	7666	Lebanon
AT	6584	Austria	FK	7075	Falkland Islands	LC	7667	Saint Lucia
AU	6585	Australia	FM	7077	Micronesia, Federated States of	LI	7673	Liechtenstein
AW	6587	Aruba	FO	7079	Faroe Islands	LK	7675	Sri Lanka
AZ	6590	Azerbaijan	FR	7082	France	LR	7682	Liberia
BA	6665	Bosnia and Herzegovina	GA	7165	Gabon	LS	7683	Lesotho
BB	6666	Barbados	GB	7166	United Kingdom	LT	7684	Lithuania
BD	6668	Bangladesh	GD	7168	Grenada	LU	7685	Luxembourg
BE	6669	Belgium	GE	7169	Georgia	LV	7686	Latvia
BF	6670	Burkina Faso	GF	7170	French Guiana	LY	7689	Libyan Arab Jamahiriya
BG	6671	Bulgaria	GH	7172	Ghana	MA	7765	Morocco
BH	6672	Bahrain	GI	7173	Gibraltar	MC	7767	Monaco
BI	6673	Burundi	GL	7176	Greenland	MD	7768	Moldova, Republic of
BJ	6674	Benin	GM	7177	Gambia	MG	7771	Madagascar
BM	6677	Bermuda	GN	7178	Guinea	MH	7772	Marshall Islands
BN	6678	Brunei Darussalam	GP	7180	Guadeloupe	MK	7775	Macedonia, The former Yugoslav Republic of
BO	6679	Bolivia	GQ	7181	Equatorial Guinea			
BR	6682	Brazil	GR	7182	Greece	ML	7776	Mali
BS	6683	Bahamas	GS	7183	South Georgia and the South Sandwich Islands	MM	7777	Myanmar
BT	6684	Bhutan				MN	7778	Mongolia
BV	6686	Bouvet Island	GT	7184	Guatemala	MO	7779	Macau
BW	6687	Botswana	GU	7185	Guam	MP	7780	Northern Mariana Islands
BY	6689	Belarus	GW	7187	Guinea-Bissau	MQ	7781	Martinique
BZ	6690	Belize	GY	7189	Guyana	MR	7782	Mauritania
CA	6765	Canada	HK	7275	Hong Kong	MS	7783	Montserrat
CC	6767	Cocos (Keeling) Islands	HM	7277	Heard Island and McDonald Islands	MT	7784	Malta
CD	6768	Congo, the Democratic Republic of the				MU	7785	Mauritius
			HN	7278	Honduras	MV	7786	Maldives
CF	6770	Central African Republic	HR	7282	Croatia	MW	7787	Malawi
CG	6771	Congo	HT	7284	Haiti	MX	7788	Mexico
CH	6772	Switzerland	HU	7285	Hungary	MY	7789	Malaysia
CI	6773	Cote d'Ivoire	ID	7368	Indonesia	MZ	7790	Mozambique
CK	6775	Cook Islands	IE	7369	Ireland	NA	7865	Namibia
CL	6776	Chile	IL	7376	Israel	NC	7867	New Caledonia
CM	6777	Cameroon	IN	7378	India	NE	7869	Niger
CN	6778	China	IO	7379	British Indian Ocean Territory	NF	7870	Norfolk Island
CO	6779	Colombia	IQ	7381	Iraq	NG	7871	Nigeria
CR	6782	Costa Rica	IR	7382	Iran, Islamic Republic of	NI	7873	Nicaragua
CU	6785	Cuba	IS	7383	Iceland	NL	7876	Netherlands
CV	6786	Cape Verde	IT	7384	Italy	NO	7879	Norway
CX	6788	Christmas Island	JM	7477	Jamaica	NP	7880	Nepal
CY	6789	Cyprus	JO	7479	Jordan	NR	7882	Nauru
CZ	6790	Czech Republic	JP	7480	Japan	NU	7885	Niue
DE	6869	Germany	KE	7569	Kenya	NZ	7890	New Zealand
DJ	6874	Djibouti	KG	7571	Kyrgyzstan	OM	7977	Oman
DK	6875	Denmark	KH	7572	Cambodia	PA	8065	Panama

Abbreviation	Code	Country	Abbreviation	Code	Country	Abbreviation	Code	Country
PE	8069	Peru	SJ	8374	Svalbard and Jan Mayen	TW	8487	Taiwan, Province of China
PF	8070	French Polynesia	SK	8375	Slovakia	TZ	8490	Tanzania, United Republic of
PG	8071	Papua New Guinea	SL	8376	Sierra Leone	UA	8565	Ukraine
PH	8072	Philippines	SM	8377	San Marino	UG	8571	Uganda
PK	8075	Pakistan	SN	8378	Senegal	UM	8577	United States Minor Outlying Islands
PL	8076	Poland	SO	8379	Somalia	US	8583	United States
PM	8077	Saint Pierre and Miquelon	SR	8382	Suriname	UY	8589	Uruguay
PN	8078	Pitcairn	ST	8384	Sao Tome and Principe	UZ	8590	Uzbekistan
PR	8082	Puerto Rico	SV	8386	El Salvador	VA	8665	Holy See (Vatican City State)
PT	8084	Portugal	SY	8389	Syrian Arab Republic	VC	8667	Saint Vincent and the Grenadines
PW	8087	Palau	SZ	8390	Swaziland	VE	8669	Venezuela
PY	8089	Paraguay	TC	8467	Turks and Caicos Islands	VG	8671	Virgin Island, British
QA	8165	Qatar	TD	8468	Chad	VI	8673	Virgin Islands, U.S
RE	8269	Reunion	TF	8470	French Southern Territories	VN	8678	Viet Nam
RO	8279	Romania	TG	8471	Togo	VU	8685	Vanuatu
RU	8285	Russian Federation	TH	8472	Thailand	WF	8770	Wallis and Futuna
RW	8287	Rwanda	TJ	8474	Tajikistan	WS	8783	Samoa
SA	8365	Saudi Arabia	TK	8475	Tokelau	YE	8969	Yemen
SB	8366	Solomon Islands	TM	8477	Turkmenistan	YT	8984	Mayotte
SC	8367	Seychelles	TN	8478	Tunisia	YU	8985	Yugoslavia
SD	8368	Sudan	TO	8479	Tonga	ZA	9065	South Africa
SE	8369	Sweden	TP	8480	East Timor	ZM	9077	Zambia
SG	8371	Singapore	TR	8482	Turkey	ZW	9087	Zimbabwe
SH	8372	Saint Helena	TT	8484	Trinidad and Tobago			
SI	8373	Slovenia	TV	8486	Tuvalu			

In Case of Difficulty

If you encounter a problem, please turn the power off, then on again. If the unit is still not functioning normally, please review the items in the following checklist. This guide will help you isolate the problem if the unit is at fault. Otherwise, make sure the rest of your system is properly connected, or then consult your authorized Alpine dealer.

Basic

No function or display.

- Vehicle's ignition is off.
 - If connected according to the instructions, the unit will not operate with the vehicle's ignition off.
- Improper power lead connections.
 - Check power lead connections.
- Blown fuse.
 - Check the fuse on the battery lead of the unit; replace with the proper value if necessary.
- Internal micro-computer malfunctioned due to interference noise, etc.
 - Press the RESET switch with a ballpoint pen or other pointed article.
- Blackout mode is activated.
 - Cancel Blackout mode.

No sound or unnatural sound.

- Incorrect setting of volume/balance/fader controls.
 - Readjust the controls.
- Connections are not properly or securely made.
 - Check the connections and firmly connect.

Screen not displayed.

- Brightness control is set at the minimum position.
 - Adjust the Brightness control.
- Temperature in the vehicle is too low.
 - Increase the vehicle's interior temperature to operation temperature range.
- Connections to the DVD, CD player, navigation system are not securely made.
 - Check the connections and firmly connect.

Movement of displayed picture is abnormal.

- Temperature in the vehicle is too high.
 - Allow the vehicle's interior temperature to cool.

Unclear or noisy display.

- Fluorescent plate is worn out.
 - Replace the fluorescent plate.

Navigation system inoperative.

- Connections to the navigation system are incorrect.
 - Check the connections with the navigation system and connect the cables correctly and firmly.

Unclear picture display.

- Fluorescent tube is exhausted.
 - Replace the fluorescent tube*.

* The fluorescent tube replacement is not free of charge even within the warranty period, for the tube is an article of consumption.

Radio

Unable to receive stations.

- No antenna, or open connection in the antenna cable.
 - Make sure the antenna is properly connected; replace the antenna or cable if necessary.

Unable to tune stations in the seek mode.

- You are in a weak signal area.
 - Make sure the tuner is in DX mode.
- If the area you are in is a primary signal area, the antenna may not be grounded and connected properly.
 - Check your antenna connections; make sure the antenna is properly grounded at its mounting location.
- The antenna may not be the proper length.
 - Make sure the antenna is fully extended; if broken, replace the antenna with a new one.

Broadcast is noisy.

- The antenna is not the proper length.
 - Extend the antenna fully; replace it if it is broken.
- The antenna is poorly grounded.
 - Make sure the antenna is grounded properly at its mounting location.
- The station signal is weak and noisy.
 - If above solution does not work, tune in another station.

CD/MP3/WMA/AAC/DVD/Video CD

Disc playback sound is wavering.

- Moisture condensation in the disc Module.
 - Allow enough time for the condensation to evaporate (about 1 hour).

Disc insertion not possible.

- A disc is already in the DVD player.
 - Eject the disc and remove it.
- The disc is being improperly inserted.
 - Make sure the disc is being inserted following the instructions in the CD/MP3/WMA/AAC, DVD/Video CD Player Operation section.

Unable to fast forward or reverse the disc.

- The disc has been damaged.
 - Eject the disc and discard it; using a damaged disc in your unit can cause damage to the mechanism.

Disc playback sound skips due to vibration.

- Improper mounting of the unit.
 - Securely re-mount the unit.
- Disc is very dirty.
 - Clean the disc.
- Disc has scratches.
 - Change the disc.
- The pick-up lens is dirty.
 - Do not use a commercial available lens cleaner disc. Consult your nearest ALPINE dealer.

Disc playback sound skips without vibration.

- Dirty or scratched disc.
 - Clean the disc; damaged disc should be replaced.

CD-R/CD-RW playback not possible.

- Close session (finalization) has not been performed.
 - Perform finalization and attempt playback again.

Error displays

- Mechanical error
 - Press **▲**. After the error indication disappears, insert the disc again. If the above-mentioned solution does not solve the problem, consult your nearest ALPINE dealer.

MP3/WMA/AAC is not played back.

- Writing error occurred. The CD format is not compatible.
 - Make sure the CD has been written in a supported format. Refer to "About MP3/WMA/AAC" (pages 17 and 18), then rewrite in the format supported by this device.

Unit does not operate.

- Monitor's power is not turned on.
 - Turn on the monitor's power.
- Condensation.
 - Wait a while (about 1 hour) for the condensation to dry.

No picture is produced.

- Monitor's mode is not switched to the mode you want to see.
 - Switch to the mode you want to see.
- Monitor's parking brake lead is not connected.
 - Connect the monitor's parking brake wire and set the parking brake.
(For details, refer to the monitor's instructions.)

Playback does not start.

- Disc is loaded upside-down.
 - Check the disc and load it with the labeled side facing upward.
- Disc is dirty.
 - Clean the disc.
- A disc not able to play back with this unit is loaded.
 - Check if the disc is able to be played back.
- Parental lock is set.
 - Cancel the parental lock or change the rating level.

Picture is unclear or noisy.

- Disc is being fast-forwarded or fast-reversed.
 - The picture may be slightly disturbed, but this is normal.
- Vehicle's battery power is weak.
 - Check the battery power and wiring.
(The unit may malfunction if the battery power is under 11 volts with a load applied.)
- Monitor's fluorescent tube is worn.
 - Replace the monitor's fluorescent tube.

Image stops sometimes.

- Disc is scratched.
 - Replaced with a non-scratched disc.

Playing back a DRM protected DivX® File

Some operations cannot be performed while displaying the following message.

"Authorization Error"

- If a non-approved DRM protected DivX® file that does not comply with the registration code of the unit is played back, "Authorization Error" is displayed for 2 seconds, meaning the file cannot be played back. After the message has been displayed, the beginning of the next file will automatically be played back.

"Rental Expired"

- There is a rental file in the DivX® that is set to audio/visual times. If audio/visual time is counted as 0, "Rental Expired" is displayed for 2 seconds, indicating that the file cannot be played back. After the message has been displayed, the beginning of the next file will automatically be played back.

"Rental countdown OK?"

- While playing back a rental file, if B.SKIP or ENTER in the file selection menu is selected, "Rental countdown OK?" is displayed, and the rental file playback is interrupted (audio/visual times are reduced by 1). The file has stopped (STOP) at the time. To interrupt the playback, touch [YES], or touch [NO] to not be interrupted.

"View DivX® VOD Rental

This rental has (remaining times) views left.

Do you want to use one of your (remaining times) views now ?"

- If audio/visual times still remain, the remaining number of playback times is displayed. To play back, touch [YES]. If the next file is to be played back, touch [NO].

Indication for CD/MP3/WMA/AAC

HI-TEMP

- Protective circuit is activated due to high temperature.
- Operations of an internal disc, DVD setup, etc., cannot be performed.
 - The indicator will disappear when the temperature returns to within operation range.
 - Leave the power OFF until the temperature decreases and then turn the power ON again.

NO DISC

- No disc is inserted.
 - Insert a disc.
- Although a disc is inserted, "NO DISC" is displayed and the unit does not start to play or eject the disc.
 - Remove the disc by following these steps:
Press **▲** for at least 3 seconds.

LOADING ERROR

EJECT ERROR

- Mechanism error.
 - 1) Press **▲** and eject the disc.
If not ejecting, consult your Alpine dealer.
 - 2) When the error indication remains after ejecting, press **▲** again.
If the error indication still does not turn off after pressing **▲** for a few times, consult your Alpine dealer.

DISC ERROR

- Scratched disc, contaminated disc/poor recording/disc incompatible with this unit.
 - Press **▲**.
 - Change the disc.

PROTECT

- A copy-protected WMA file was played back.
 - You can only play back non-copy-protected files.

UNSUPPORTED

- A sampling rate/bit rate not supported by the unit is used.
 - Use a sampling rate/bit rate that is supported by the unit.
-

Indication for DVD/Video CD

NO DISC

- No disc is inserted.
 - Insert a disc.
 - Although a disc is inserted, "NO DISC" is displayed and the unit does not start to play or eject the disc.
 - Remove the disc by following these steps:
 - Press ▲ for at least 3 seconds.
-



- Button operation on the unit or remote control is not possible.
 - For some discs or playing modes, certain operations are not possible. This is not a malfunction.
-

HI-TEMP

- Protective circuit is activated to high temperature.
 - The indicator will disappear when the temperature returns to within operation range.
 - Leave the power OFF until the temperature decreases and then turn the power ON again.
-

REGIONAL CODE VIOLATION

- Disc does not match regional code number.
 - Load a disc that matches the regional code number.
-

LOADING ERROR

EJECT ERROR

- Mechanism error.
 - 1) Press ▲ and eject the disc.
 - If not ejecting, consult your Alpine dealer.
 - 2) When the error indication remains after ejecting, press ▲ again.
 - If the error indication still does not turn off after pressing ▲ for a few times, consult your Alpine dealer.
-

DISC ERROR

- Scratched disc, contaminated disc/poor recording/disc incompatible with this unit.
 - Press ▲.
 - Change the disc.
-

EJECT DISC BEFORE USING DVD-SETUP

- The DVD setup operation was attempted when a disc is inserted in the unit.
 - Eject the disc before the DVD setup operation.
-

Indication for CD changer

HI-TEMP

- Protective circuit is activated due to high temperature.
 - The indicator will disappear when the temperature returns to within operation range.
-

ERROR01

- Malfunction in the CD Changer.
 - Consult your Alpine dealer. Press the magazine eject button and pull out the magazine.
 - Check the indication. Insert the magazine again.
 - If the magazine cannot be pulled out, consult your Alpine dealer.
 - Magazine ejection not possible.
 - Press the magazine eject button. If the magazine does not eject, consult your Alpine dealer.
-

ERROR02

- A disc is left inside the CD Changer.
 - Press the Eject button to activate the eject function. When the CD Changer finishes the eject function, insert an empty CD magazine into the CD Changer to receive the disc left inside the CD Changer.
-

NO MAGAZINE

- No magazine is loaded into the CD Changer.
 - Insert a magazine.
-

NO DISC

- No indicated disc.
 - Choose another disc.
-

Indication for SAT Receiver Mode

ANTENNA

- The XM or SIRIUS antenna is not connected to the XM or SIRIUS radio module.
 - Check whether the XM or SIRIUS antenna cable is attached securely to the XM or SIRIUS radio module.
-

UPDATING

- Radio is being updated with latest encryption code.
 - Wait until encryption code is being updated. Channels 0 and 1 should function normally.
-

NO SIGNAL (XM mode)

ACQUIRING (SIRIUS mode)

- XM or SIRIUS signal is too weak at the current location.
 - Wait until the car reaches a location with a stronger signal.
-

LOADING

- Radio is acquiring audio or program information.
 - Wait until the radio has received the information.
-

OFF AIR (XM mode)

ACQUIRING (SIRIUS mode)

- The channel currently selected has stopped broadcasting.
 - Select another channel.
-

- The user has selected a channel number that does not exist or is not subscribed to.
 - The unit will revert back to the previously selected channel.
- There is no artist name/feature, song/program title, or additional information associated with the channel at that time.
 - No action needed.

Indication for iPod Mode

NO iPod

- The iPod is not connected.
 - Make sure the iPod is correctly connected (refer to “connections”).
 - Make sure the cable is not bent excessively.
 - The iPod’s battery remains low.
 - Refer to the iPod’s documentation and charge the battery.
-

NO SONG

- There are no songs in the iPod.
 - Download songs to the iPod and connect to the IVA-D105.
-

ERROR01

- Communication error
 - Turn the ignition key off, and then set to ON again.
 - Check the display by reconnecting between the iPod and the unit, using the iPod cable.
-

ERROR02

- Caused by the iPod Software Version not being compatible with this unit.
 - Update the iPod Software Version to be compatible with this unit.

Specifications

MONITOR SECTION

Screen Size	6.5"
LCD Type	Transparent type TN LCD
Operation System	TFT active matrix
Number of Picture Elements	280,800 pcs. (1200 × 234)
Effective Number of Picture Elements	99.99% or more
Illumination System	Cold cathode fluorescent tube

FM TUNER SECTION

Tuning Range	87.7 – 107.9 MHz
Mono Usable Sensitivity	9.3 dBf (0.8 μV/75 ohms)
50 dB Quietening Sensitivity	13.5 dBf (1.3 μV/75 ohms)
Alternate Channel Selectivity	80 dB
Signal-to-Noise Ratio	65 dB
Stereo Separation	35 dB
Capture Ratio	2.0 dB

AM TUNER SECTION

Tuning Range	530 – 1,710 kHz
Usable Sensitivity	22.5 μV/27.0 dBf

CD/DVD SECTION

Frequency Response	5 – 20,000 Hz
Wow & Flutter (% WRMS)	Below measurable limits
Total Harmonic Distortion	0.008% (at 1 kHz)
Dynamic Range	95 dB (at 1 kHz)
Channel Separation	85 dB (at 1 kHz)
Signal system	NTSC/PAL
Horizontal resolution	500 lines or greater
Video output level	1Vp-p (75 ohms)
Video S/N ratio	DVD: 60 dB
Audio S/N ratio	More than 105 dB

PICKUP

Wave length	
DVD:	666 nm
CD:	785 nm
Laser power	CLASS II

REMOTE CONTROL

Battery Type	CR2025 battery
Width	51 mm (2")
Height	119 mm (4-11/16")
Depth	13 mm (1/2")
Weight	40 g (1.4 oz) (battery excluded)

GENERAL

Power Requirement	14.4 V DC (11–16 V allowable)
Operating temperature	+32°F to +113°F (0°C to +45°C)
Power Output	18 W RMS × 4* * Primary amplifier ratings per CEA-2006 Standard • Power output: measured at 4 Ohms and ≤ 1% THD+N • S/N: 80 dBA (reference: 1 W into 4 Ohms)
Output Voltage	2,000 mV / 10k ohms
Bass	- 14 dB / +20 dB at 60 Hz
Treble	± 14 dB at 10 kHz
Weight	2.6 kg (5 lbs. 12 oz)

Audio output level	
Preout (Front, Rear):	2V/10k ohms (max.)
Preout (Subwoofer, Center):	2V/10k ohms (max.)
AUX OUT:	1.2V/10k ohms
Ai-NET:	850 mV

CHASSIS SIZE (Monitor section)

Width	178 mm (7")
Height	50 mm (2")
Depth	165 mm (6-1/2")

- Due to continuous product improvement, specifications and design are subject to change without notice.
- The LCD panel is manufactured using an extremely high precision manufacturing technology. Its effective pixel ratio is over 99.99%. This means that there is a possibility that 0.01% of the pixels could be either always ON or OFF.

CAUTION

CAUTION-Laser radiation when open, DO NOT STARE INTO BEAM

(Bottom side of Monitor player)

Installation and Connections

Before installing or connecting the unit, please read the following and pages 5 to 7 of this manual thoroughly for proper use.

Warning

MAKE THE CORRECT CONNECTIONS

Failure to make the proper connections may result in fire or product damage.

USE ONLY IN CARS WITH A 12 VOLT NEGATIVE GROUND.

(Check with your dealer if you are not sure.) Failure to do so may result in fire, etc.

BEFORE WIRING, DISCONNECT THE CABLE FROM THE NEGATIVE BATTERY TERMINAL.

Failure to do so may result in electric shock or injury due to electrical shorts.

DO NOT ALLOW CABLES TO BECOME ENTANGLED IN SURROUNDING OBJECTS.

Arrange wiring and cables in compliance with the manual to prevent obstructions when driving. Cables or wiring that obstruct or hang up on places such as the steering wheel, gear lever, brake pedals, etc. can be extremely hazardous.

DO NOT SPLICE INTO ELECTRICAL CABLES.

Never cut away cable insulation to supply power to other equipment. Doing so will exceed the current carrying capacity of the wire and result in fire or electric shock.

DO NOT DAMAGE PIPE OR WIRING WHEN DRILLING HOLES.

When drilling holes in the chassis for installation, take precautions so as not to contact, damage or obstruct pipes, fuel lines, tanks or electrical wiring. Failure to take such precautions may result in fire.

DO NOT USE BOLTS OR NUTS IN THE BRAKE OR STEERING SYSTEMS TO MAKE GROUND CONNECTIONS.

Bolts or nuts used for the brake or steering systems (or any other safety-related system), or tanks should NEVER be used for installations or ground connections. Using such parts could disable control of the vehicle and cause fire etc.

KEEP SMALL OBJECTS SUCH AS BOLTS OR SCREWS OUT OF THE REACH OF CHILDREN.

Swallowing them may result in serious injury. If swallowed, consult a physician immediately.

DO NOT INSTALL IN LOCATIONS WHICH MIGHT HINDER VEHICLE OPERATION, SUCH AS THE STEERING WHEEL OR GEARSHIFT.

Doing so may obstruct forward vision or hamper movement etc. and results in serious accident.

Caution

HAVE THE WIRING AND INSTALLATION DONE BY EXPERTS.

The wiring and installation of this unit requires special technical skill and experience. To ensure safety, always contact the dealer where you purchased this product to have the work done.

USE SPECIFIED ACCESSORY PARTS AND INSTALL THEM SECURELY.

Be sure to use only the specified accessory parts. Use of other than designated parts may damage this unit internally or may not securely install the unit in place. This may cause parts to become loose resulting in hazards or product failure.

ARRANGE THE WIRING SO IT IS NOT CRIMPED OR PINCHED BY A SHARP METAL EDGE.

Route the cables and wiring away from moving parts (like the seat rails) or sharp or pointed edges. This will prevent crimping and damage to the wiring. If wiring passes through a hole in metal, use a rubber grommet to prevent the wires insulation from being cut by the metal edge of the hole.

DO NOT INSTALL IN LOCATIONS WITH HIGH MOISTURE OR DUST.

Avoid installing the unit in locations with high incidence of moisture or dust. Moisture or dust that penetrates into this unit may result in product failure.

Precautions

- Be sure to disconnect the cable from the (-) battery post before installing your IVA-D105. This will reduce any chance of damage to the unit in case of a short-circuit.
- Be sure to connect the color coded leads according to the diagram. Incorrect connections may cause the unit to malfunction or damage to the vehicle's electrical system.
- When making connections to the vehicle's electrical system, be aware of the factory installed components (e.g. on-board computer). Do not tap into these leads to provide power for this unit. When connecting the IVA-D105 to the fuse box, make sure the fuse for the intended circuit of the IVA-D105 has the appropriate amperage. Failure to do so may result in damage to the unit and/or the vehicle. When in doubt, consult your ALPINE dealer.
- The IVA-D105 uses female RCA-type jacks for connection to other units (e.g. amplifier) having RCA connectors. You may need an adaptor to connect other units. If so, please contact your authorized ALPINE dealer for assistance.
- Be sure to connect the speaker (-) leads to the speaker (-) terminal. Never connect left and right channel speaker cables to each other or to the vehicle body.
- The Display must be completely retracted in the casing when installing. If it is not, problems may occur.
- When installing in automobiles, make sure the Display can open/close without coming in contact with the gear shift.

IMPORTANT

Please record the serial number of your unit in the space provided below and keep it as a permanent record. The serial number plate is located on the bottom of the unit.

SERIAL NUMBER: _____

INSTALLATION DATE: _____

INSTALLATION TECHNICIAN: _____

PLACE OF PURCHASE: _____

Installation

Caution

Do not block the unit's fan or heat sink, thus preventing air circulation. If blocked, heat will accumulate inside the unit and may cause a fire.

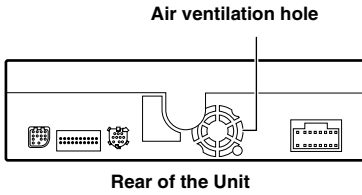

Installing the Monitor

Installation Location

Before deciding on the mounting location, check that opening and closing the display will not hamper gear shifting in that position.

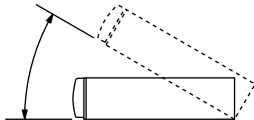

- Install at an angle of within 30 degrees from the horizontal.
- The monitor's angle is set to 90 degrees at the factory. Depending on the car, the monitor may hit the dashboard when opened. The monitor's angle can be adjusted and stored in memory so that the monitor will not hit the dashboard when opening. For adjusting the monitor, refer to "Adjusting the Monitor Angle" on page 39. Even when the vehicle's battery power is removed, the adjusted monitor angle remains stored in memory.

1

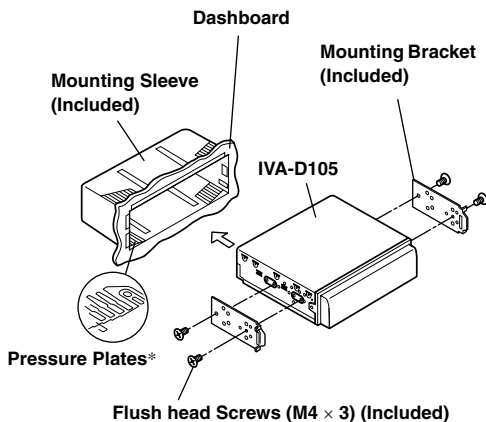

Slide the mounting sleeve into the dashboard. Install the supplied bracket on the monitor.

- Make sure to use the supplied Flush head screw (M4 x 3) to install the monitor. If you use another screw to install the monitor, it may cause a malfunction.

* If the installed mounting sleeve is loose in the dashboard, the pressure plates may be bent slightly to remedy the problem.

2

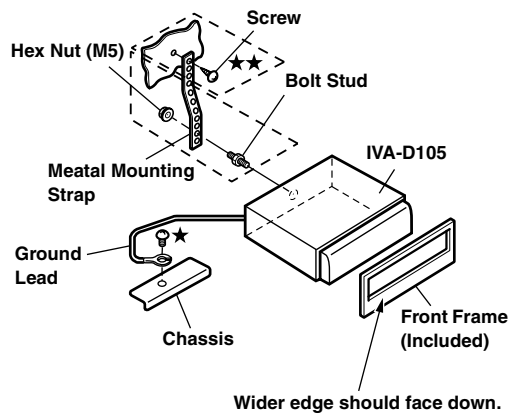

Reinforce the monitor unit with a metal mounting strap (not supplied). Secure the ground lead of the unit to a clean metal spot using a screw (★) already attached to the vehicle's chassis.

- For the screw marked ★ ★, use an appropriate screw for the chosen mounting location.

Connect each input lead coming from an amplifier or equalizer to the corresponding output lead coming from the left rear of the IVA-D105. Connect all other leads of the IVA-D105 according to details described in the Connections section.

3

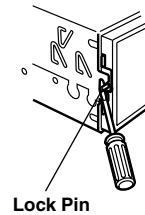

Slide the IVA-D105 into the dashboard. When the unit is in place, make sure the locking pins are fully seated in the down position. This can be done by pressing firmly on the unit while pushing the locking pin down with a small screwdriver. This ensures that the unit is properly locked and will not accidentally come out from the dashboard. Install the supplied Front Frame.

Removal

1. Use a small screwdriver (or similar tool) to push the locking pins to the "up" position (see Step 3). As each pin is unlocked, gently pull out on the unit to make sure it does not re-lock before unlocking the second pin.
2. Pull the unit out, keeping it unlocked as you do so.

< JAPANESE CAR >

To install using the vehicle's standard bracket.

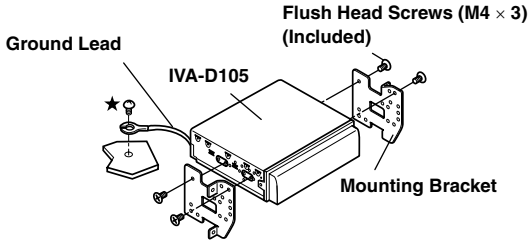

- Make sure to use the supplied flush head screw (M4 × 3) to install the monitor.
If you use another screw to install the monitor, it may cause a malfunction. However, only if you cannot install with the flush head screws (M4 × 3), use the supplied screw (M4 × 6).

Foot Brake Lead / Parking Brake Lead Connection

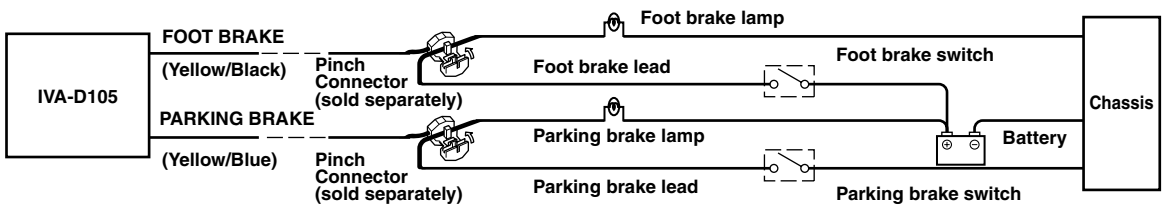

Connection Diagram of SPST Switch (Sold Separately)

(If the ACC power supply is not available)

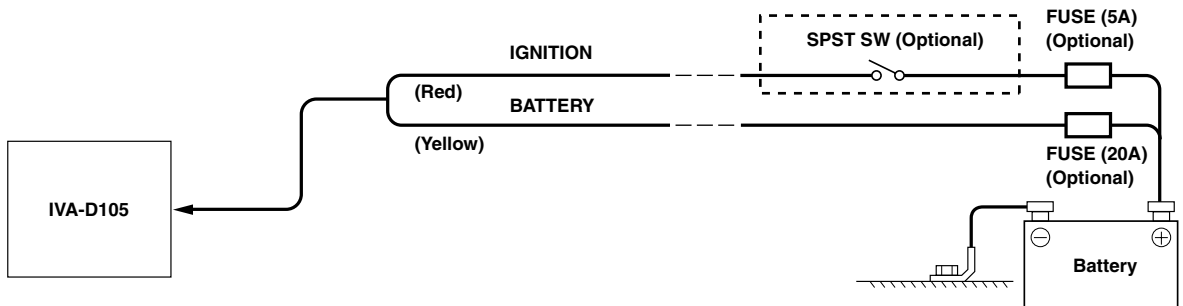

- If your vehicle has no ACC power supply, add an SPST (Single-Pole, Single-Throw) switch (sold separately) and fuse (sold separately).
- The diagram and the fuse amperage shown above are in the case when IVA-D105 is used individually.
- If the switched power (ignition) lead of the IVA-D105 is connected directly to the positive (+) post of the vehicle's battery, the IVA-D105 draws some current (several hundred milliamperes) even when its switch is placed in the OFF position and the battery may be discharged.

To prevent external noise from entering the audio system.

- Locate the unit and route the leads at least 10 cm away from the car harness.
- Keep the battery power leads as far away from other leads as possible.
- Connect the ground lead securely to a bare metal spot (remove any paint, dirt or grease if necessary) of the car chassis.
- If you add an optional noise suppressor, connect it as far away from the unit as possible. Your Alpine dealer carries various noise suppressors, contact them for further information.
- Your Alpine dealer knows best about noise prevention measures so consult your dealer for further information.

Connections

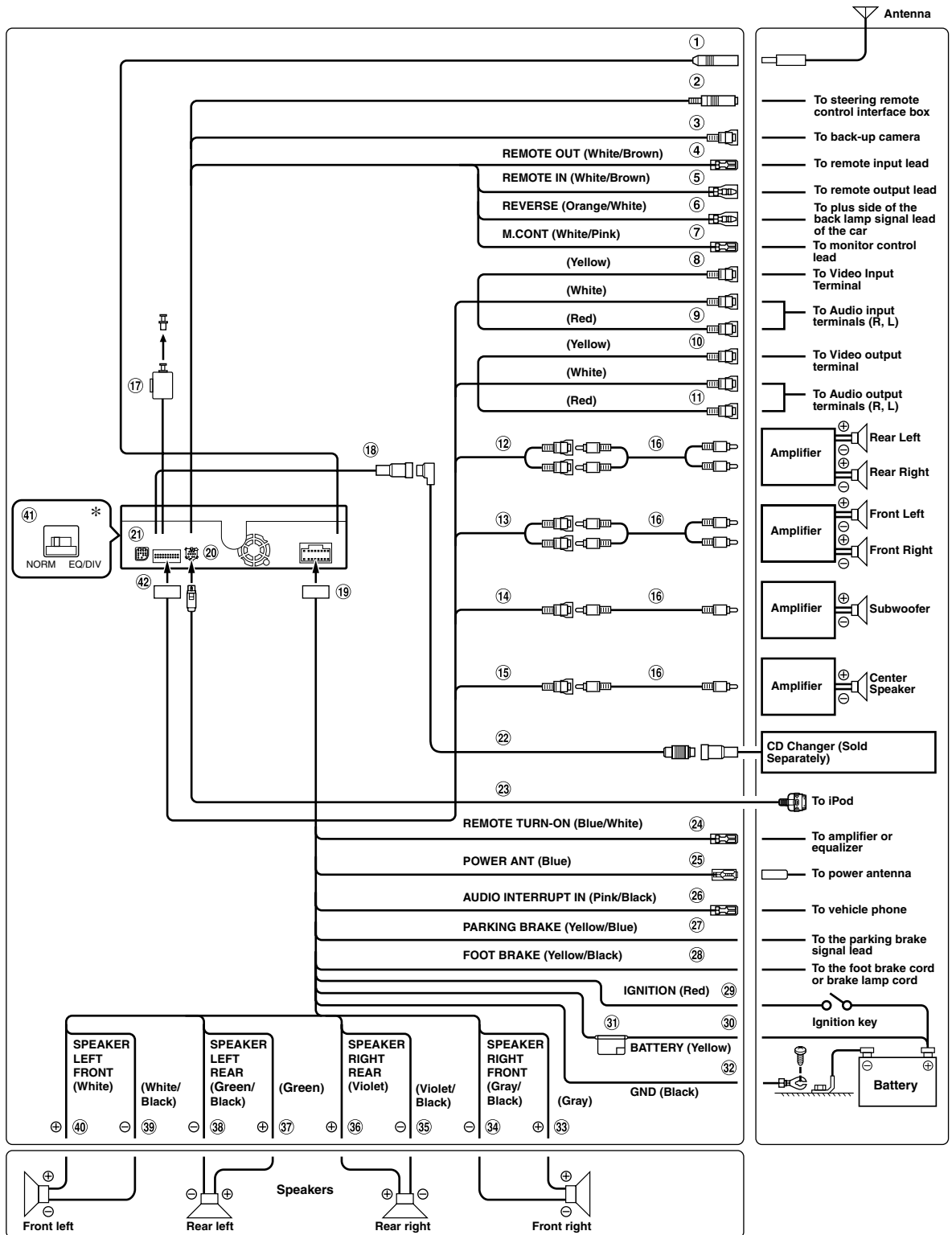

- Set the system switch to "NORM" when only a changer is connected (when the Ai-NET compatible equalizer is not used).
- * The system switch is located on the right of the unit (if the front panel is viewed from the front).

- ① **Antenna Receptacle**
- ② **Steering Remote Control Interface Connector**
To steering remote control interface box.
For details about connections, consult your nearest Alpine dealer.
- ③ **CAMERA Input Terminal**
Use when connecting a back-up camera.
- ④ **Remote Control Output Lead (White/Brown)**
Connect this lead to the remote control input lead. This lead outputs the controlling signals from the remote control.
- ⑤ **Remote Control Input Lead (White/Brown)**
Connect the external Alpine product to the remote control output lead.
- ⑥ **Reverse Lead (Orange/White)**
Use only when a back-up camera is connected. Connect to the plus side of the car's reverse lamp that lights when the transmission is shifted into reverse (R).
Switches the video picture to the back-up camera. This is linked with putting the car into reverse (R).
- ⑦ **Monitor Control Lead (White/Pink)**
Connect this to the Monitor Control Lead of the touch panel-compatible rear monitor.
- ⑧ **Video Output Connector (AUX OUTPUT) (Yellow)**
Output the video.
- ⑨ **Audio Output Connectors (AUX OUTPUT)**
RED is right and WHITE is left output the audio.
- ⑩ **Video Input Connector (AUX INPUT) (Yellow)**
Input the video.
- ⑪ **Audio Input Connectors (AUX INPUT)**
RED is right and WHITE is left input the audio.
- ⑫ **Rear Output RCA Connectors**
RED is right and WHITE is left.
- ⑬ **Front Output RCA Connectors**
RED is right and WHITE is left.
- ⑭ **Subwoofer Output RCA Connector**
- ⑮ **Center RCA Connector**
- ⑯ **RCA Extension Cable (sold separately)**
- ⑰ **Digital Output Terminal (Optical)**
Use when combining fiber optic digital input compatible products.
- ⑱ **Ai-NET Connector**
Connect this to the output or input connector of another device (CD Changer, Equalizer, HD Radio™ TUNER MODULE, etc.) equipped with Ai-NET.
 - You can input TV/video sound by connecting an optional Ai-NET/RCA Interface cable (KCA-121B) to this component.
- ⑲ **Power Supply Connector**
- ⑳ **iPod Direct Connector.**
iPod control signals.
Connect this to an iPod or an optional Bluetooth Box, using the FULL SPEED™ Connection Cable (KCE-422i) (sold separately).
To use a hands-free mobile phone, an optional Bluetooth Box connection is required. For details on connection, refer to the Owner's Manual of the Bluetooth Box.
- ㉑ **RGB Input Terminal**
Connect this to the RGB output terminal of the Navigation System.
- ㉒ **Ai-NET Cable (Included with CD Changer)**
- ㉓ **FULL SPEED™ Connection Cable (KCE-422i) (sold separately)**
- ㉔ **Remote Turn-On Lead (Blue/White)**
Connect this lead to the remote turn-on lead of your amplifier or signal processor.
- ㉕ **Power Antenna Lead (Blue)**
Connect this lead to the +B terminal of your power antenna, if applicable.
 - This lead should be used only for controlling the vehicle's power antenna. Do not use this lead to turn on an amplifier or a signal processor, etc.
- ㉖ **Audio Interrupt In Lead (Pink/Black)**
- ㉗ **Parking Brake Lead (Yellow/Blue)**
Connect this lead to the power supply side of the parking brake switch to transmit the parking brake status signals to the IVA-D105.
- ㉘ **Foot Brake Lead (Yellow/Black)**
Connect to the vehicle's foot brake lead or brake lamp lead.
- ㉙ **Switched Power Lead (Ignition) (Red)**
Connect this lead to an open terminal on the vehicle's fuse box or another unused power source which provides (+) 12V only when the ignition is turned on or in the accessory position.
- ㉚ **Battery Lead (Yellow)**
Connect this lead to the positive (+) post of the vehicle's battery.
- ㉛ **Fuse Holder (10A)**
- ㉜ **Ground Lead (Black)**
Connect this lead to a good chassis ground on the vehicle. Make sure the connection is made to bare metal and is securely fastened using the sheet metal screw provided.
- ㉝ **Right Front (+) Speaker Output Lead (Gray)**
- ㉞ **Right Front (-) Speaker Output Lead (Gray/Black)**
- ㉟ **Right Rear (-) Speaker Output Lead (Violet/Black)**
- ㊱ **Right Rear (+) Speaker Output Lead (Violet)**
- ㊲ **Left Rear (+) Speaker Output Lead (Green)**
- ㊳ **Left Rear (-) Speaker Output Lead (Green/Black)**
- ㊴ **Left Front (-) Speaker Output Lead (White/Black)**
- ㊵ **Left Front (+) Speaker Output Lead (White)**
- ㊶ **System Switch**
When connecting an equalizer or divider using Ai-NET feature, place this switch in the EQ/DIV position. When no device is connected, leave the switch in the NORM position.
 - Be sure to turn the power off to the unit before changing the switch position.
- ㊷ **AV Connector**

System Example

Connect the Ai-NET compatible audio processor (Fiber optic digital compatible), Navigation system, DVD player and changer.

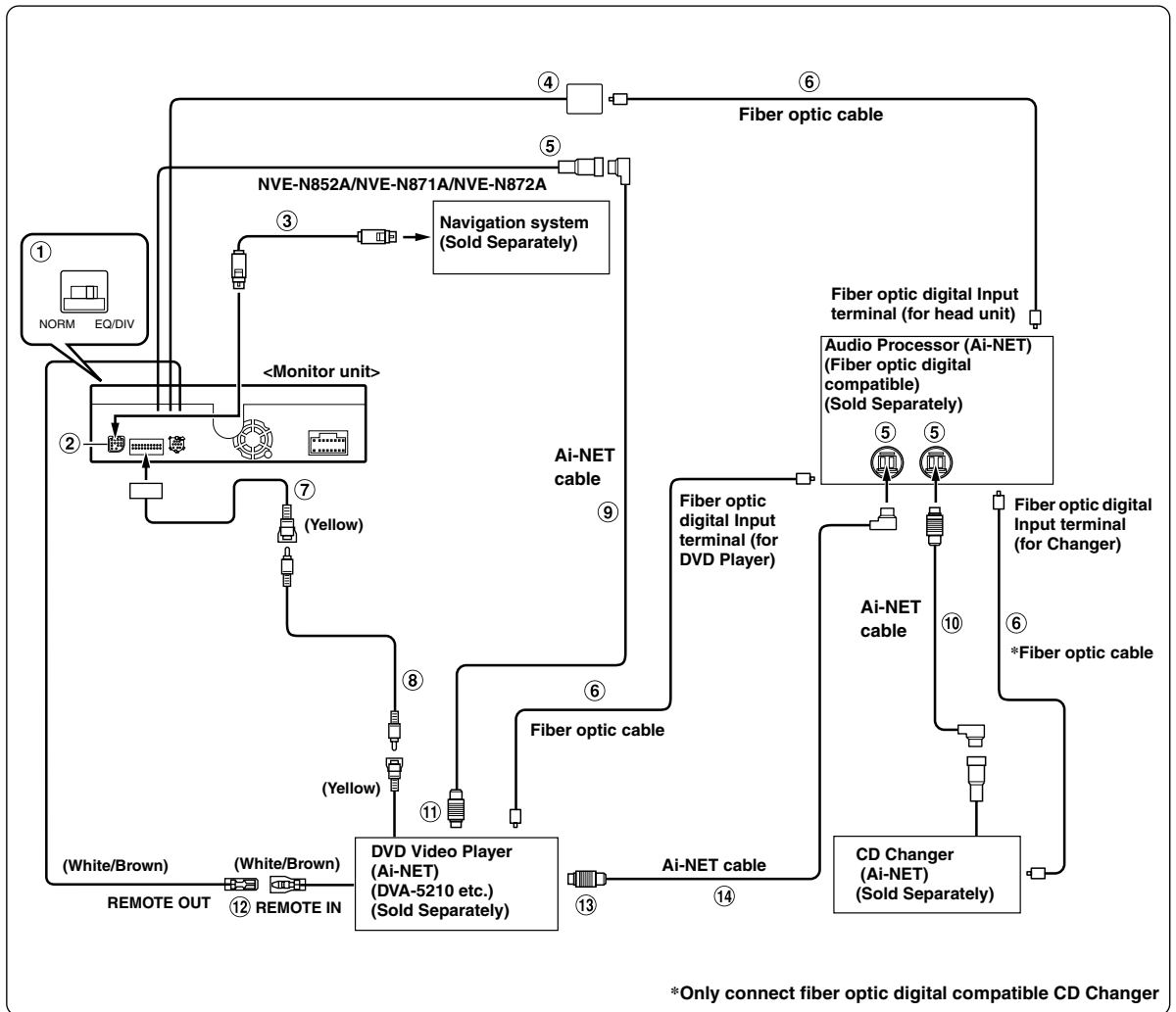

- When the fiber optic compatible product is connected, it is necessary to set the mode of this unit. Refer to "Setting the Digital Output" (page 38) and set to ON.
- When the NVA-N751AS is connected for the Navigation System, use the RGB conversion cable KWE-503N (Sold separately).

Please observe the following when using Fiber Optic Cable.

- Do not coil the Fiber Optic Cable smaller than a 30 mm radius.
- Do not place anything on top of the Fiber Optic Cable.
- Be careful not to bend the Fiber Optic Cable at a sharp angle.

① **System Switch**

When connecting an equalizer or divider using Ai-NET feature, place this switch in the EQ/DIV position. When no device is connected, leave the switch in the NORM position.

- *Be sure to turn the power off to the unit before changing the switch position.*

② **RGB Input Terminal**

Connect this to the RGB output terminal of the Navigation System.

③ **RGB Cable (Included with NVE-N852A/NVE-N872A, not included with NVE-N871A)**

④ **Digital Output Terminal**

⑤ **Ai-NET Connector**

Connect this to the output or input connector of other product equipped with Ai-NET.

⑥ **Fiber optic Cable (Sold Separately)**

⑦ **Video Input Connector (AUX INPUT) (Yellow)**

Connect the video output lead of a DVD video player or DVD changer to this terminal.

⑧ **RCA Extension Cable (Included with DVD video player)**

⑨ **Ai-NET Cable (Included with DVD video player)**

⑩ **Ai-NET Cable (Included with CD Changer)**

⑪ **To Ai-NET Connector (Gray)**

⑫ **Remote Control Output Lead (White/Brown)**

Connect this lead to the remote control input lead. This lead outputs the controlling signals from the remote control.

⑬ **To Ai-NET Connector (Black)**

⑭ **Ai-NET Cable (Included with Audio Processor)**

When Connecting External Equipment

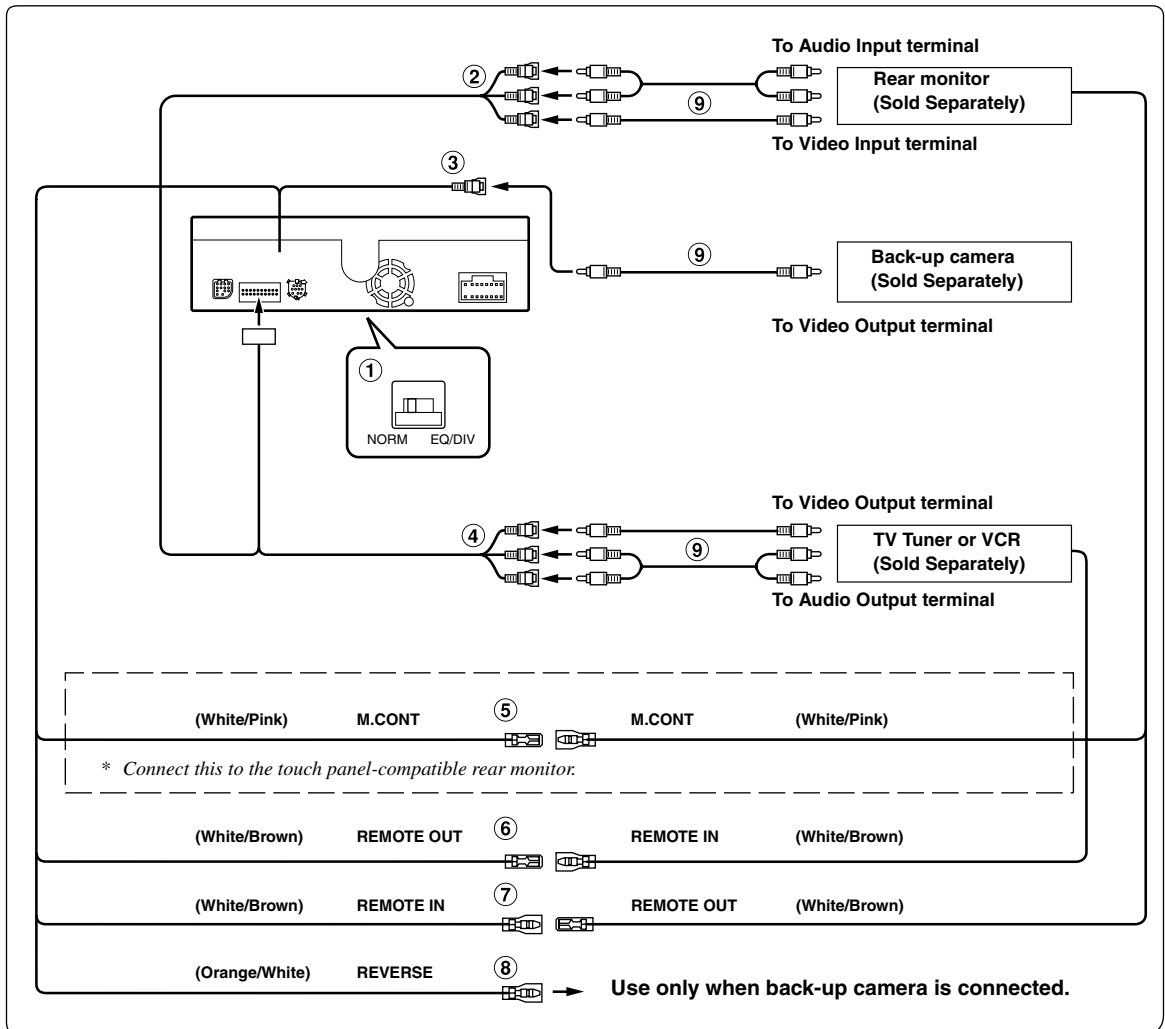

① System Switch

When connecting an equalizer or divider using Ai-NET feature, place this switch in the EQ/DIV position. When no device is connected, leave the switch in the NORM position.

- Be sure to turn the power off to the unit before changing the switch position.

② Video/Audio Output Connectors (AUX OUTPUT)

Use when connecting an optional monitor etc.

③ CAMERA Input Terminal

Use when connecting a back-up camera.

④ Video/Audio Input Connectors (AUX INPUT)

⑤ Monitor Control Lead (White/Pink)

Connect this to the Monitor Control Lead of the touch panel-compatible rear monitor.

⑥ Remote Control Output Lead (White/Brown)

Connect this lead to the remote control input lead. This lead outputs the controlling signals from the remote control.

⑦ Remote Control Input Lead (White/Brown)

⑧ Reverse Lead (Orange/White)

Connect to the plus side of the car's reverse lamp which lights when the transmission is shifted into reverse (R). Switches the video picture to the back-up camera. This is linked to putting the car into reverse (R).

⑨ RCA Extension Cable (Sold separately)



LIMITED WARRANTY

ALPINE ELECTRONICS OF AMERICA, INC. AND ALPINE OF CANADA INC. ("Alpine"), are dedicated to quality craftsmanship and are pleased to offer this Warranty. We suggest that you read it thoroughly. Should you have any questions, please contact your Dealer or contact Alpine at one of the telephone numbers listed below.

● PRODUCTS COVERED:

This Warranty covers Car Audio Products and Related Accessories ("the product"). Products purchased in the Canada are covered only in the Canada. Products purchased in the U.S.A. are covered only in the U.S.A.

● LENGTH OF WARRANTY:

This Warranty is in effect for one year from the date of the first consumer purchase.

● WHO IS COVERED:

This Warranty only covers the original purchaser of the product, who must reside in the United States, Puerto Rico or Canada.

● WHAT IS COVERED:

This Warranty covers defects in materials or workmanship (parts and labor) in the product.

● WHAT IS NOT COVERED:

This Warranty does not cover the following:

- ① Damage occurring during shipment of the product to Alpine for repair (claims must be presented to the carrier).
- ② Damage caused by accident or abuse, including burned voice coils caused by over-driving the speaker (amplifier level is turned up and driven into distortion or clipping). Speaker mechanical failure (e.g. punctures, tears or rips). Cracked or damaged LCD panels. Dropped or damaged hard drives.
- ③ Damage caused by negligence, misuse, improper operation or failure to follow instructions contained in the Owner's manual.
- ④ Damage caused by act of God, including without limitation, earthquake, fire, flood, storms or other acts of nature. Any cost or expense related to the removal or reinstallation of the product.
- ⑤ Service performed by an unauthorized person, company or association.
- ⑥ Any product which has the serial number defaced, altered or removed.
- ⑦ Any product which has been adjusted, altered or modified without Alpine's consent.
- ⑧ Any product not distributed by Alpine within the United States, Puerto Rico or Canada.
- ⑨ Any product not purchased from an Authorized Alpine Dealer.

● HOW TO OBTAIN WARRANTY SERVICE:

- ① You are responsible for delivery of the product to an Authorized Alpine Service Center or Alpine for repair and for payment of any initial shipping charges. Alpine will, at its option, repair or replace the product with a new or reconditioned product without charge. If the repairs are covered by the warranty, and if the product was shipped to an Authorized Alpine Service Center or Alpine, Alpine will pay the return shipping charges.
- ② You should provide a detailed description of the problem(s) for which service is required.

- ③ You must supply proof of your purchase of the product.
- ④ You must package the product securely to avoid damage during shipment. To prevent lost packages it is recommended to use a carrier that provides a tracking service.

● HOW WE LIMIT IMPLIED WARRANTIES:

ANY IMPLIED WARRANTIES INCLUDING FITNESS FOR USE AND MERCHANTABILITY ARE LIMITED IN DURATION TO THE PERIOD OF THE EXPRESS WARRANTY SET FORTH ABOVE AND NO PERSON IS AUTHORIZED TO ASSUME FOR ALPINE ANY OTHER LIABILITY IN CONNECTION WITH THE SALE OF THE PRODUCT.

● HOW WE EXCLUDE CERTAIN DAMAGES:

ALPINE EXPRESSLY DISCLAIMS LIABILITY FOR INCIDENTAL AND CONSEQUENTIAL DAMAGES CAUSED BY THE PRODUCT. THE TERM "INCIDENTAL DAMAGES" REFERS TO EXPENSES OF TRANSPORTING THE PRODUCT TO THE ALPINE SERVICE CENTER, LOSS OF THE ORIGINAL PURCHASER'S TIME, LOSS OF THE USE OF THE PRODUCT, BUS FARES, CAR RENTALS OR OTHERS COSTS RELATING TO THE CARE AND CUSTODY OF THE PRODUCT. THE TERM "CONSEQUENTIAL DAMAGES" REFERS TO THE COST OF REPAIRING OR REPLACING OTHER PROPERTY WHICH IS DAMAGED WHEN THIS PRODUCT DOES NOT WORK PROPERLY. THE REMEDIES PROVIDED UNDER THIS WARRANTY ARE EXCLUSIVE AND IN LIEU OF ALL OTHERS.

● HOW STATE/PROVINCIAL LAW RELATES TO THE WARRANTY:

This Warranty gives you specific legal rights, and you may also have other rights which vary from state to state and province to province. In addition, some states/provinces do not allow limitations on how long an implied warranty lasts, and some do not allow the exclusion or limitation of incidental or consequential damages. Accordingly, limitations as to these matters contained herein may not apply to you.

● IN CANADA ONLY:

This Warranty is not valid unless your Alpine car audio product has been installed in your vehicle by an Authorized Installation Center, and this warranty stamped upon installation by the installation center.

● HOW TO CONTACT CUSTOMER SERVICE:

Should the product require service, please call the following number for your nearest Authorized Alpine Service Center.

CAR AUDIO	1-800-ALPINE-1 (1-800-257-4631)
NAVIGATION	1-888-NAV-HELP (1-888-628-4357)

Or visit our website at; <http://www.alpine-usa.com>

ALPINE ELECTRONICS OF AMERICA, INC., 19145 Gramercy Place, Torrance, California 90501, U.S.A.

ALPINE ELECTRONICS OF CANADA, INC., 777 Supertest Road, Toronto, Ontario M3J 2M9, Canada

Do not send products to these addresses.

Call the toll free telephone number or visit the website to locate a service center.